

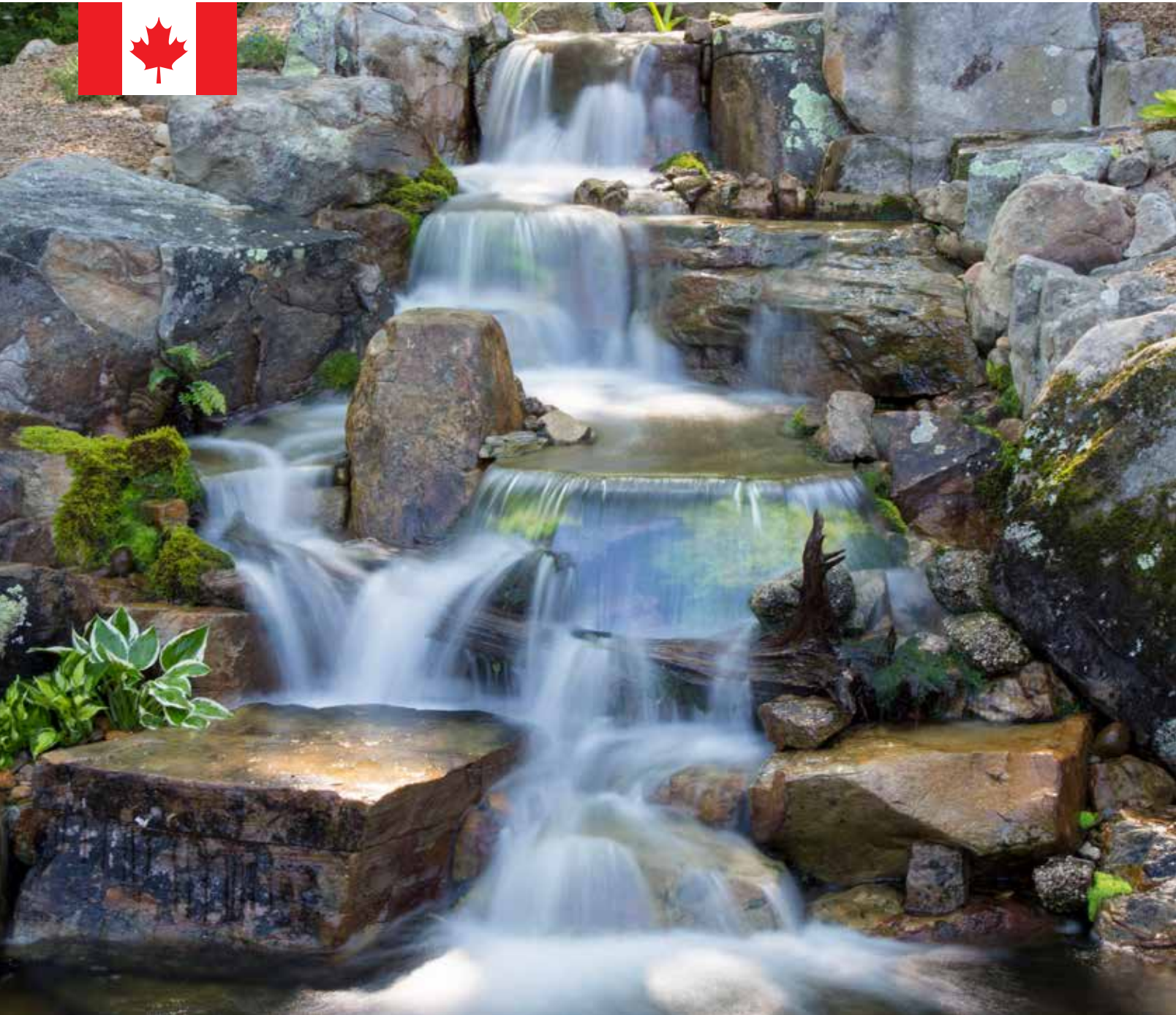

Water Features

2019 PRODUCT CATALOGUE



The leading water feature manufacturer in North America.

Thank you for 28 years of support!

Your Paradise. Our Passion.® That's our motto at Aquascape. We strive each and every day to provide the best products and services in the water feature industry.

Whether you are experienced or new to the world of water features, we invite you to explore our comprehensive selection of products designed to build, enhance, and maintain a wide variety of water features, including ponds, waterfalls, and fountains.





From our expansive selection of high-quality products with long-term warranties to our industry-leading training events and experienced Customer Care and Technical Support teams, we are here to ensure your success installing, selling, or enjoying Aquascape water features.

Welcome to the Wonderful World of Water Features!

*Greg Wittstock
"The Pond Guy"*





LIVING THE AQUASCAPE LIFESTYLE

At **Aquascape**, our passion is helping people transform both their outdoor living space and how they spend their leisure time. "Living the Aquascape Lifestyle" is about having an escape at home. When you live with a pond, waterfall, or fountain, you are drawn outside, away from daily stresses, to interact with your landscape in a variety of ways. Water feature owners enjoy feeding colorful fish, watching birds splash in a waterfall, or simply listening to the tranquil sounds of moving water. The benefits are plentiful, and Aquascape makes it easier than ever to enjoy the Aquascape Lifestyle.

TABLE OF CONTENTS

■ Pond Kits	6
■ Pondless® Waterfall Kits	10
■ Filtration	14
■ Pumps	30
■ Aeration	48
■ Lighting	52
■ Water Treatments	61
■ Predator Control	78
■ Seasonal Care	79
■ Fish Care	82
■ Aquatic Plant Care	87
■ Decorative	90
■ Liner, Underlayment, and Geotextile	109
■ Pipe and Plumbing	113
■ Installation Tools	117
■ Rainwater Harvesting	120

SYMBOL KEY

	Fire Fountain Add-On Kit Available		2-Year Warranty
	Ideal for Cold Weather		3-Year Warranty
	Pump Included		5-Year Warranty
	Great for Container Water Gardens		Limited Lifetime Warranty
	New Product		



POND KITS

Aquascape Ecosystem Pond Approach

Ecosystem ponds work with nature, not against it, providing an all-natural, low-maintenance piece of paradise. Each component of the ecosystem pond plays a key role in keeping ponds balanced, clean, and clear.

Filtration System

Includes the use of both a biological and a mechanical filter.

- A BioFalls® filter provides surface area for beneficial bacteria to colonize and remove excess nutrients from the water.
- A pond skimmer pre-filters the water and houses the pump, collecting surface debris and reducing pond maintenance.

Rocks and Gravel

Rocks and gravel protect the liner, naturalize the pond bottom, and provide tremendous surface area for beneficial bacteria to break down excess nutrients in the water.

Circulation System

Proper water flow throughout the pond helps to maintain necessary oxygen levels, provide beauty, optimize water quality, and minimize maintenance.

Fish

Fish make great pets and are an integral part of any ecosystem. Not only do fish provide nutrients for your aquatic plants, but they also graze on excess algae growth, reducing maintenance.

Aquatic Plants

Plants, Mother Nature's true filters, provide color and texture and help to balance the entire pond ecosystem, minimizing maintenance and improving water conditions by absorbing excess nutrients.

The Ecosystem Pond

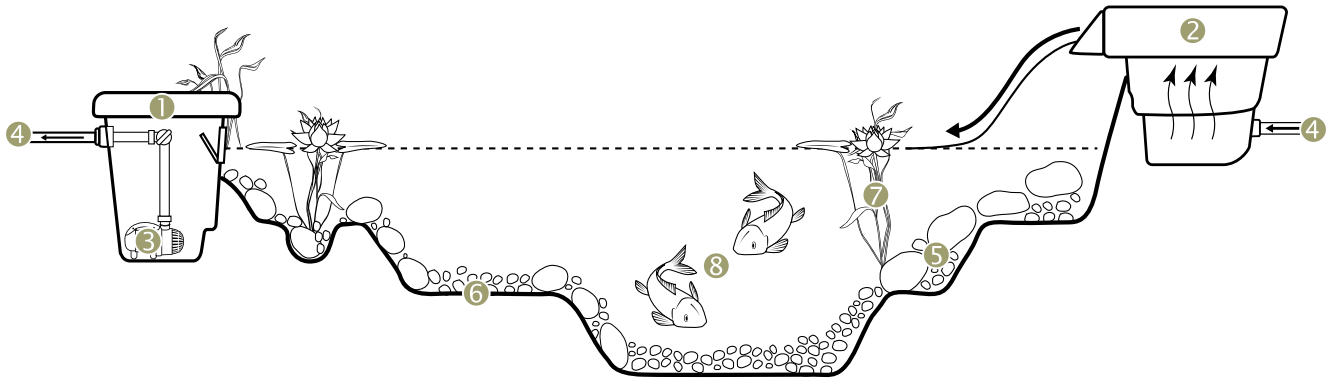

① Pond Skimmer

④ Pipe

⑦ Plants

② BioFalls® Filter

⑤ Rocks and Gravel

⑧ Fish

③ Pond Pump

⑥ Pond Liner and Underlayment

Step-By-Step

1
Carefully remove contents from box.

2
Select your location.

3
Use garden hose and outline area.

4
Position the filters.

5
Dig the hole.

6
Level the excavation.

7
Install underlayment and liner.

8
Add rock and gravel.

9
Fill the pond.

ENJOY!

Pond Kits



DIY Backyard Pond Kits

Kit Includes:

- Signature Series 200 Pond Skimmer
- Signature Series 1000 BioFalls® Filter and BioBalls Biological Filter Media
- AquaSurge® 2000 Pond Pump
- Kink-Free Pipe—1.5" x 25'
- 45 mil EPDM Liner
- Non-Woven Geotextile Underlayment
- Installation Kit
 - Fittings
 - Silicone Sealant
 - Pond and Waterfall Foam Sealant
- Welcome Kit



Small Pond Kit 8' x 11'

Kit Includes:

- Signature Series 400 Pond Skimmer
- Signature Series 1000 BioFalls® Filter, Rock Tray, and BioBalls Biological Filter Media
- AquaSurge® 3000 Pond Pump
- Flexible PVC Pipe—1.5" x 25'
- 45 mil EPDM Liner—12' x 15' to build a 8' x 11' pond with a maximum depth of 2'
- Non-Woven Geotextile Underlayment—180 sq. ft.
- Pump Check Valve Assembly
- Installation Kit
 - Silicone Sealant
 - EPDM Liner Patch
 - Pond and Waterfall Foam Sealant
 - Christy's Red Hot Blue Glue
- Automatic Dosing System for Ponds—Includes Water Treatment
- Welcome Kit

DIY Backyard Pond Kit 4' x 6'

Includes 8' x 10' liner to build a 4' x 6' pond with a maximum depth of 2'

#83005

Packaged Weight: 73 lb

DIY Backyard Pond Kit 6' x 8'

Includes 10' x 12' liner to build a 6' x 8' pond with a maximum depth of 2'

#83006

Packaged Weight: 85 lb

DIY Backyard Pond Kit 8' x 11'

Includes 12' x 15' liner to build a 8' x 11' pond with a maximum depth of 2'

#83007

Packaged Weight: 105 lb

Small Pond Kit 8' x 11'

#53043

Packaged Weight: 140 lb

Pond Kits



Medium Pond Kits 11' X 16'

Kit Includes:

- Signature Series 1000 Pond Skimmer
- Signature Series 2500 BioFalls® Filter, Rock Tray, Faux Rock Lip, and BioBalls Biological Filter Media
- Choice of Pond Pump:
 - AquaSurge® 2000-4000 Adjustable Flow Pond Pump
 - OR**
 - 3-PL 3000 Solids-Handling Pond Pump
- Flexible PVC Pipe—2" x 25'
- 45 mil EPDM Liner—15' x 20' to build a 11' x 16' pond with a maximum depth of 2'
- Non-Woven Geotextile Underlayment—300 sq. ft.
- Pump Check Valve Assembly
- Installation Kit
 - Silicone Sealant
 - EPDM Liner Patch
 - Pond and Waterfall Foam Sealant
 - Christy's Red Hot Blue Glue
- Garden and Pond LED Lighting Package
 - (2) 3-Watt LED Spotlights
 - 1-Watt LED Waterfall and Up Light
 - 60-Watt Transformer with Photocell
 - 3-Way Splitter and 25' Quick-Connect Extension Cable
- Automatic Dosing System for Ponds—Includes Water Treatment
- Welcome Kit

Medium Pond Kit 11' x 16'
with AquaSurge® 2000-4000 Pond Pump

#53044

Packaged Weight: 215 lb

Medium Pond Kit 11' x 16'
with 3-PL 3000 Solids-Handling Pond Pump

#53045

Packaged Weight: 218 lb



Large Pond Kits 21' X 26'

Kit Includes:

- Signature Series 1000 Pond Skimmer
- Signature Series 6000 BioFalls® Filter, Rock Tray, and BioBalls Biological Filter Media
- Choice of Pond Pump:
 - AquaSurge® 4000-8000 Adjustable Flow Pond Pump
 - OR**
 - 9-PL 7000 Solids-Handling Pond Pump
- Flexible PVC Pipe—2" x 50'
- 45 mil EPDM Liner—25' x 30' to build a 21' x 26' pond with a maximum depth of 2'
- Non-Woven Geotextile Underlayment—750 sq. ft.
- Pump Check Valve Assembly
- Installation Kit
 - Silicone Sealant
 - EPDM Liner Patch
 - Pond and Waterfall Foam Sealant
 - Christy's Red Hot Blue Glue
- Garden and Pond LED Lighting Package
 - (2) 3-Watt LED Spotlights
 - 1-Watt LED Waterfall and Up Light
 - 60-Watt Transformer with Photocell
 - 3-Way Splitter and 25' Quick-Connect Extension Cable
- Automatic Dosing System for Ponds—Includes Water Treatment
- Welcome Kit

Large Pond Kit 21' x 26'
with AquaSurge® 4000-8000 Pond Pump

#53046

Packaged Weight: 405 lb

Large Pond Kit 21' x 26'
with 9-PL 7000 Solids-Handling Pond Pump

#53047

Packaged Weight: 409 lb



PONDLESS® WATERFALL KITS

What is a Pondless® Waterfall?

A Pondless® Waterfall is simply a re-circulating waterfall or stream without the presence of a pond. The waterfall works by pumping water from a large, in-ground reservoir up to the top of the waterfall, allowing the water to flow back down into the reservoir. This simple recirculation system is easy to install, low-maintenance, and ideal for families with young children or pets that love to play in the water.

Enjoy the beauty and soothing sounds of a waterfall in any location. Tuck a small waterfall near the front entrance of your home to greet visitors, or add a meandering stream to your backyard.

You can easily add a pond to your waterfall later, if you decide you'd like to keep fish and enjoy a larger variety of aquatic plants.

The Pondless® Waterfall

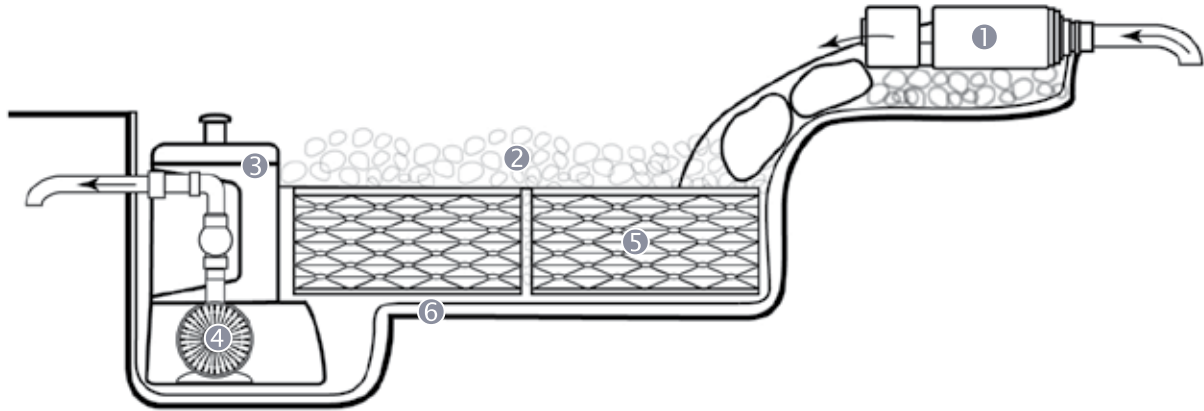

① Waterfall Spillway

④ Pond Pump

② Rocks and Gravel

⑤ AquaBlox® Water Storage Modules

③ Pondless® Waterfall Vault

⑥ Liner and Underlayment

Step-By-Step

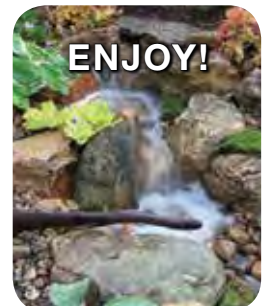
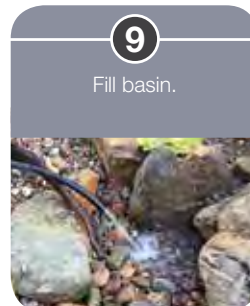
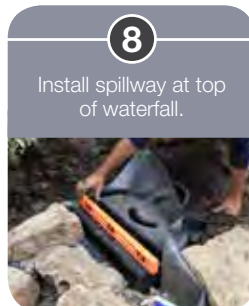
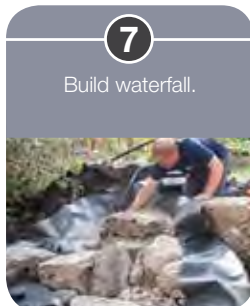
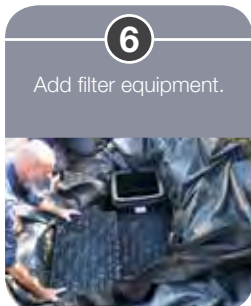
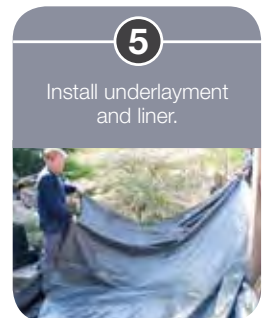
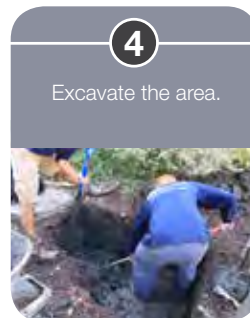
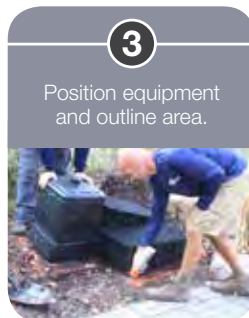
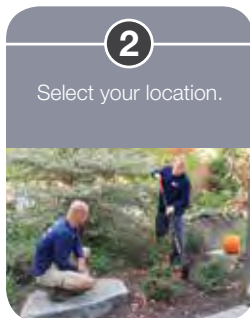

Pondless® Waterfall Kits

Backyard Waterfall Landscape Fountain Kit*



Kit Includes:

- Waterfall Spillway
- AquaBasin® 45
- AquaSurge® 2000 Pond Pump
- AquaSurge® Low Suction Intake Attachment
- Flexible PVC Pipe—1.5" x 15'
- 45 mil EPDM Liner - 7.5' x7.5' Liner
- Installation Kit
 - Fittings
 - Silicone Sealant
 - Pond and Waterfall Foam Sealant
- Welcome Kit

Backyard Waterfall Landscape Fountain Kit

#83013C

Packaged Weight: 147 lb

See page 98 for more information.

* NOTE: Uses the AquaBasin® 45 instead of the AquaBlox® Water Storage Modules and the Pondless® Waterfall Vault.



DIY Pondless® Waterfall Kit

Kit Includes:

- Waterfall Spillway
- Pondless® Waterfall Vault
- (2) AquaBlox® Small Water Storage Modules
- AquaSurge® 2000 Pond Pump
- 45 mil EPDM Liner—10' x 12' Liner
- Non-Woven Geotextile Underlayment—105 sq. ft.
- Kink-Free Pipe—1.5" x 25'
- Installation Kit
 - Fittings
 - Silicone Sealant
 - Pond and Waterfall Foam Sealant
- Welcome Kit

DIY Backyard Waterfall Kit

#83001C

Packaged Weight: 80 lb



Small Pondless® Waterfall Kit 6' Stream

Kit Includes:

- Waterfall Spillway
- Pondless® Waterfall Vault
- (3) AquaBlox® Small Water Storage Modules
- AquaSurge® 2000–4000 Adjustable Flow Pond Pump
- Flexible PVC Pipe—1.5" x 25'
- 45 mil EPDM Liner—10' x 10'
- 45 mil EPDM Stream Liner—10' x 8' Liner
- Non-Woven Geotextile Underlayment—100 sq. ft.
- Pump Check Valve Assembly
- Installation Kit
 - Silicone Sealant
 - EPDM Liner Patch
 - Pond and Waterfall Foam Sealant
 - Christy's Red Hot Blue Glue
- Automatic Dosing System for Fountains—Includes Water Treatment
- Welcome Kit

Small Pondless® Waterfall Kit 6' Stream

#53038C

Packaged Weight: 149 lb

Pondless® Waterfall Kits



Medium Pondless® Waterfall Kit 16' Stream

Kit Includes:

- Waterfall Spillway
- Pondless® Waterfall Vault
- (5) AquaBlox® Small Water Storage Modules
- Choice of Pond Pump:
 - AquaSurge® 2000-4000 Adjustable Flow Pond Pump
- OR**
- 3-PL 3000 Solids-Handling Pond Pump
- Flexible PVC Pipe—2" x 25'
- 45 mil EPDM Liner—10' x 12'
- 45 mil EPDM Stream Liner—10' x 20' Liner
- Non-Woven Geotextile Underlayment—120 sq. ft.
- Pump Check Valve Assembly
- Installation Kit
 - Silicone Sealant
 - EPDM Liner Patch
 - Pond and Waterfall Foam Sealant
 - Christy's Red Hot Blue Glue
- Garden and Pond LED Lighting Package
 - (2) 1-Watt LED Waterfall and Up Lights
 - 60-Watt Transformer with Photocell
 - 3-Way Splitter and 25' Quick-Connect Extension Cable
- Automatic Dosing System for Fountains—Includes Water Treatment
- Welcome Kit

Medium Pondless® Waterfall Kit 16' Stream

with AquaSurge® 2000–4000 Pond Pump

#53039C

Packaged Weight: 215 lb

Medium Pondless® Waterfall Kit 16' Stream

with 3-PL 3000 Solids-Handling Pond Pump

#53040C

Packaged Weight: 215 lb



Large Pondless® Waterfall Kit 26' Stream

Kit Includes:

- Waterfall Spillway
- Pondless® Waterfall Vault
- (5) AquaBlox® Large Water Storage Modules
- Choice of Pond Pump:
 - AquaSurge® 4000-8000 Adjustable Flow Pond Pump
- OR**
- 5-PL 5000 Solids-Handling Pond Pump
- Flexible PVC Pipe—2" x 50'
- 45 mil EPDM Liner—12' x 15'
- 45 mil EPDM Stream Liner—10' x 30' Liner
- Non-Woven Geotextile Underlayment—180 sq. ft.
- Pump Check Valve Assembly
- Installation Kit
 - Silicone Sealant
 - EPDM Liner Patch
 - Pond and Waterfall Foam Sealant
 - Christy's Red Hot Blue Glue
- Garden and Pond LED Lighting Package
 - (3) 1-Watt LED Waterfall and Up Lights
 - 60-Watt Transformer with Photocell
 - 3-Way Splitter and 25' Quick-Connect Extension Cable
- Automatic Dosing System for Fountains—Includes Water Treatment
- Welcome Kit

Large Pondless® Waterfall Kit 26' Stream

with AquaSurge® 4000–8000 Pond Pump

#53041C

Packaged Weight: 309 lb

Large Pondless® Waterfall Kit 26' Stream

with 5-PL 5000 Solids-Handling Pond Pump

#53042C

Packaged Weight: 313 lb



FILTRATION

The Science Behind Filtration

There are two forms of filtration critical to maintaining a healthy ecosystem pond: mechanical and biological. Through mechanical and biological filtration, the water garden will process a variety of nutrients found in the system, including fish waste, uneaten fish food, leaves, and runoff from lawns.

How to Choose the Right Filter for Your Pond

To keep your pond or water feature looking beautiful, it is important to provide proper filtration. There are advantages to every type of filter, so we will list the features and benefits of each option, making it simple and easy to select the correct filter for your application.

New Ponds

The advantage of choosing the right filter before you get started should not be underestimated. Aquascape takes an ecosystem approach to water gardening. This approach uses a skimmer and BioFalls®. The skimmer removes leaves and debris from the surface of the pond, optimizing water quality. A BioFalls® Filter performs two very important functions: it supports mechanical and biological filtration and provides a great start to any waterfall.

Existing Ponds

In some circumstances it can be challenging to add a skimmer and BioFalls® to an existing system. Perhaps the shape or building technique makes it prohibitive. In this situation we recommend the use of an UltraKlean™ Pond Filter, Submersible Pond Filter, Pond Waterfall Filter, or Pond Filter Urn. These filters will retrofit quickly into existing systems and provide efficient mechanical and biological filtration.

Pond Skimmer Filters

Pond skimmers are designed to eliminate water quality problems and reduce maintenance by removing debris before it sinks to the bottom of the pond, allowing a pond to be installed anywhere, even beneath trees. Because the skimmer removes debris before it reaches the pump, it acts as a pre-filter, reducing pump maintenance and making pump access quick and easy. All pond skimmers include a limited lifetime warranty.

U.S. PATENT 7,144,501



Signature Series
200 Pond Skimmer
#43020

Packaged Weight: 15.9 lb
Dimensions: 20"L x 17.5"W x 17.5"H



Signature Series
400 Pond Skimmer
#43021

Packaged Weight: 21 lb
Dimensions: 21.5"L x 18"W x 21"H



Signature Series
1000 Pond Skimmer
#43022

Packaged Weight: 27 lb
Dimensions: 21"L x 22"W x 26.5"H



Features of the Signature Series 400 and 1000 Pond Skimmers

- ① Natural looking faux-rock lid conceals the filter in the surrounding landscape
- ② Patented adjustable faceplate allows you to adjust the water level after installation (1000 only)
- ③ Large volume, rigid debris basket makes maintenance easier than ever
- ④ Injection molded fittings provide professional, watertight seals
- ⑤ Corrosion-resistant, non-cross-threading hardware stands up to the elements
- ⑥ Rigid filter mat effectively removes smaller sediment and debris
- ⑦ Rounded shape provides maximum strength
- ⑧ Innovative locking weir door for ease of maintenance

Pond Skimmer Specification Chart

Model	Signature Series 200 Pond Skimmer	Signature Series 400 Pond Skimmer	Signature Series 1000 Pond Skimmer
Pond Size	up to 200 sq. ft.	up to 400 sq. ft.	up to 1,000 sq. ft.
Pump Flow Rate	up to 3,000 GPH / 11,360 LPH	up to 4,000 GPH / 15,140 LPH	up to 10,000 GPH / 37,850 LPH*
Weir Size	6"	6"	8"
Adjustable Height Face Plate	–	–	Included
Leaf & Debris Net	Included	–	–
Leaf & Debris Rigid Basket	–	Included	Included
Filter Brush Cartridge	Optional	–	–
Overflow Kit	Optional	Included	Included
Filter Mat	–	Included	Included
Dimensions	20"L x 17.5"W x 17.5"H	21.5"L x 18"W x 21"H	21"L x 22"W x 26.5"H
Warranty	Limited Lifetime	Limited Lifetime	Limited Lifetime

* NOTE: 12-PN 10,000 and AquascapePRO 10,000 pumps are too large to fit in these skimmers. Multiple pumps can be used to achieve up to 10,000 GPH.

BioFalls® Filters

Aquascape Professional Grade BioFalls® Filters provide the most filtration and highest water flows in the market. Durable, rotationally-molded polyethylene construction ensures maximum strength, and all Signature Series BioFalls® Filters include a limited lifetime warranty.



Signature Series 1000
BioFalls® Filter
#99774

Packaged Weight: 11 lb
Dimensions: 17.5"L x 20.5"W x 17"H



Signature Series 2500
BioFalls® Filter
#09020

Packaged Weight: 23 lb
Dimensions: 24"L x 29.5"W x 20"H



Signature Series 6000
BioFalls® Filter
with 2" Bulkhead
#29319

Packaged Weight: 55 lb
Dimensions: 40"L x 45"W x 29.5"H



Signature Series 6000
BioFalls® Filter
with 3" Bulkhead
#29384

Packaged Weight: 57 lb
Dimensions: 40"L x 45"W x 29.5"H

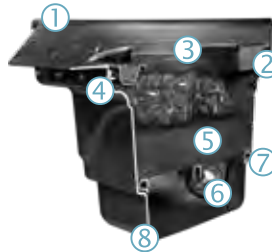

Features of the BioFalls® 2500 and 6000 Filter

- ① Reversible waterfall lip provides the option of using a natural stone spillway
- ② Removable rock tray holds rocks, plants, and gravel, helping to naturalize the filter into the landscape
- ③ BioFalls® Filter Media Net (BioBalls sold separately*)
- ④ Corrosion-resistant, non-cross-threading hardware stands up to the elements
- ⑤ Two Poly-Flo ESA biological filter mats provide 50% more surface area than traditional filter mats
- ⑥ Two bulkhead ports provide multiple plumbing options
- ⑦ Filter support rack ensures evenly distributed water flow through filter mats and provides structural strength to the walls of the filter
- ⑧ Circular shape provides maximum strength and makes it easy to camouflage into the landscape

BioFalls® Filter Specification Chart

Model	Signature Series 1000 BioFalls® Filter	Signature Series 2500 BioFalls® Filter	Signature Series 6000 BioFalls® Filter	Signature Series 6000 BioFalls® Filter—3" Bulkhead
Filters Ponds up to	1,000 gal / 3,800 L	2,500 gal / 9,500 L	6,000 gal / 22,700 L	6,000 gal / 22,700 L
Pump Flow Rate	up to 3,000 GPH / 11,400 LPH	up to 5,000 GPH / 18,900 LPH	up to 15,000 GPH / 56,800 LPH	up to 15,000 GPH / 56,800 LPH
Spillway Width	15"	21.5"	28"	28"
Bulkhead Port	Single 2"	Dual 2"	Dual 2"	Dual 3"
Fittings Included	1.5" PVC slip and 1.5" kink-free insert	Two 2" PVC slip	Two 2" PVC slip	Two 3" PVC slip
Rock Tray	Optional	Included	Included	Included
Filter Mats	Two Included	Two Included	Two Included	Two Included
BioBalls (quantity)	100*	200*	400*	400*
Filter Media Nets	One Included	Two Included	Three Included	Three Included
Dimensions	17.5"L x 20.5"W x 17"H	24"L x 29.5"W x 20"H	40"L x 45"W x 29.5"H	40"L x 45"W x 29.5"H
Warranty	Limited Lifetime	Limited Lifetime	Limited Lifetime	Limited Lifetime

* NOTE: BioBalls not included. See page 28.

Pondless® Waterfall Vault



Pondless® Waterfall Vault
#49000

Packaged Weight: 14 lb

The Pondless® Waterfall Vault is the ideal pump vault for use in Pondless® Waterfalls, Rainwater Harvesting Systems, and large fountains, effectively protecting the pump and simplifying maintenance.

- Simple to install and maintain
- Fits a wide range of pump sizes and flow rates
- Ideal for use with the AquaBlox® Water Storage Modules
- Extensions can be used to extend the height for deeper applications
- Made from durable rotationally-molded polyethylene



Pondless® Waterfall Vault Extension
#49001

Packaged Weight: 5.4 lb

Slides onto the Pondless® Waterfall Vault to increase its height for applications using AquaBlox® Large Water Storage Modules or taller pumps.



Features of the Pondless® Waterfall Vault

- ① Built-in water level inspection port allows the lid to be buried out of sight
- ② Extra wide opening provides easy pump access
- ③ Excellent water circulation through water intakes
- ④ Large interior fits a wide range of pump sizes

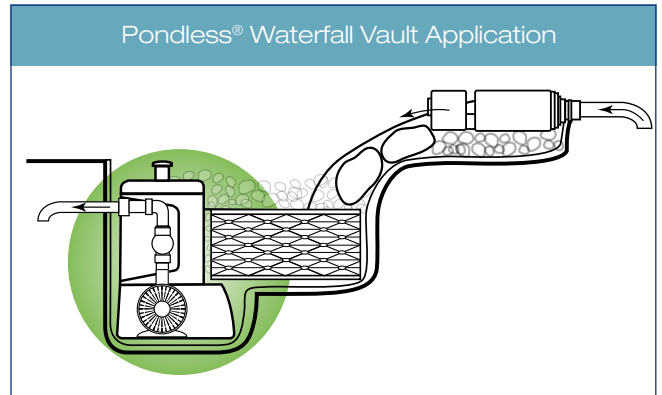

Pondless® Waterfall Vault & Extension Specification Chart

	Vault	Vault Extension
Dimensions	23"L x 17"W x 25.5"H	16"L x 16"W x 9"H
Access Opening Dimensions	16"L x 16"W	16"L x 16"W
Pump Flow Rates	up to 12,500 GPH / 47,300 LPH	—

UltraKlean™ Pond Filters

Aquascape UltraKlean™ Pond Filters provide optimum water quality and crystal clear pond water. The unique sponge-free design minimizes maintenance and maximizes efficient mechanical and biological filtration. The simple-to-use cleaning feature allows the unit to be backwashed in less than five minutes without opening the canister or getting hands dirty.

- Efficiently traps dirt and debris
- Includes high-output UV clarifier and integrated electronic bulb-saver function
- Easily integrated into new or existing ponds
- Eliminates green water caused by suspended algae



UltraKlean™ 2000 Pond Filter
#95053

Packaged Weight: 12 lb
Dimensions: 13"L x 13"W x 17"H



UltraKlean™ 3500 Pond Filter
#95054

Packaged Weight: 15 lb
Dimensions: 13"L x 13"W x 21.5"H



Features of the UltraKlean™ Pond Filters

- ① UV clarifier/sterilizer on/off LED indicator light
- ② Cleaning indicator light signals when it's time to backwash
- ③ Electronic ballast ensures optimum wattage and bulb output
- ④ UV bulb-saver timer feature maximizes bulb life and provides an ideal time to add bacteria
- ⑤ Backwash valve and discharge shutoff valve make it easy to quickly clean the filter
- ⑥ Water inlet diffuser evenly distributes debris, maximizing mechanical filtration
- ⑦ UV clarifier/sterilizer eliminates single-celled algae commonly known as green water
- ⑧ BioBalls provide efficient biological/mechanical filtration
- ⑨ Backwash swirl diffuser efficiently churns the water to clean the filter media

UltraKlean™ Product Specification Chart

Model	UltraKlean™ 2000	UltraKlean™ 3500
Average Pond Size Recommendation	2,000 gal / 7,600 L	3,500 gal / 13,000 L
Maximum Flow Rate (GPH)	2,700 GPH / 10,200 LPH	5,200 GPH / 19,800 LPH
UV Wattage	14	28
Power Cord Length	20'	20'
Discharge Hose Diameter	1", 1.25", 1.5"	1", 1.25", 1.5"
Dimensions	13"L x 13"W x 17"H	13"L x 13"W x 21.5"H
Warranty	3-Year Limited	3-Year Limited



FITTINGS INCLUDED

6 x 1", 1¼", 1½" Mult-Hose Adapters, Backwash Cap, 8 x Washers, Backflush Valve, Threaded Adapter

UltraKlean™ Pond Filtration Kits

Aquascape UltraKlean™ Pond Filtration Kits take the guesswork out of selecting the correct pump and filtration combination for any new or existing pond. Three kit sizes are available, ensuring there is a filtration kit for almost any pond.



UltraKlean™ 1500 Pond Filtration Kit
#95058

Packaged Weight: 38 lb

Pressure Filter and Pump Kit Includes:

- UltraKlean™ 2000 Pond Filter with integrated 14-Watt UV clarifier/sterilizer
- AquaForce® 1000 Solids-Handling Pond Pump
- Kink-Free Pipe—1.5" x 25'
- (4) Stainless Steel Hose Clamps
- Provides filtration for ponds up to 1,500 gal / 5,678 L



UltraKlean™ 2500 Pond Filtration Kit
#95059

Packaged Weight: 40 lb

Pressure Filter and Pump Kit Includes:

- UltraKlean™ 2000 Pond Filter with integrated 14-Watt UV clarifier/sterilizer
- AquaForce® 2700 Solids-Handling Pond Pump
- Kink-Free Pipe—1.5" x 25'
- (4) Stainless Steel Hose Clamps
- Provides filtration for ponds up to 2,500 gal / 9,464 L



UltraKlean™ 3500 Pond Filtration Kit
#95060

Packaged Weight: 45 lb

Pressure Filter and Pump Kit Includes:

- UltraKlean™ 3500 Pond Filter with integrated 28-Watt UV clarifier/sterilizer
- AquaForce® 5200 Solids-Handling Pond Pump
- 2-Way Flow Control Valve
- Kink-Free Pipe—1.5" x 25'
- (4) Stainless Steel Hose Clamps
- Provides filtration for ponds up to 3,500 gal / 13,249 L



UltraKlean™ 1000 Pond Filtration Kit
#77014

Packaged Weight: 32 lb

Filter and Pump Kit Includes:

- Signature Series 1000 BioFalls® Filter
- AquaForce® 2700 Solids-Handling Pond Pump
- Kink-Free Pipe—1.5" x 25'
- (4) Stainless Steel Hose Clamps
- Provides filtration for ponds up to 1,000 gal / 3,800 L

Submersible Pond Filter

The Aquascape® Submersible Pond Filter provides efficient mechanical and biological filtration. This unobtrusive filter can be added to the intake of almost any submersible water pump, resulting in crystal clear water while reducing pond pump maintenance.

- For ponds up to 800 gallons
- Provides mechanical and biological filtration
- Pre-filters pump for reduced maintenance
- Removable cage for easy cleaning
- Keeps pond water clean, clear, and healthy
- Includes pre-filtration sponge and ceramic filtration rings



Submersible Pond Filter

#95110

Packaged Weight: 4.5 lb



Features of the Submersible Pond Filter

- ① The large surface area and small openings of the cage prevents large debris from clogging the filter
- ② The pre-filtration sponge provides efficient mechanical and biological filtration and dramatically reduces pump maintenance
- ③ The included threaded intake and multi-hose adapter makes it easy to adapt to most pond pumps with a small piece of kink-free pipe or threaded fitting
- ④ The ceramic filtration rings provide surface area for beneficial bacteria to colonize, providing efficient biological filtration

Submersible Pond Filter Application

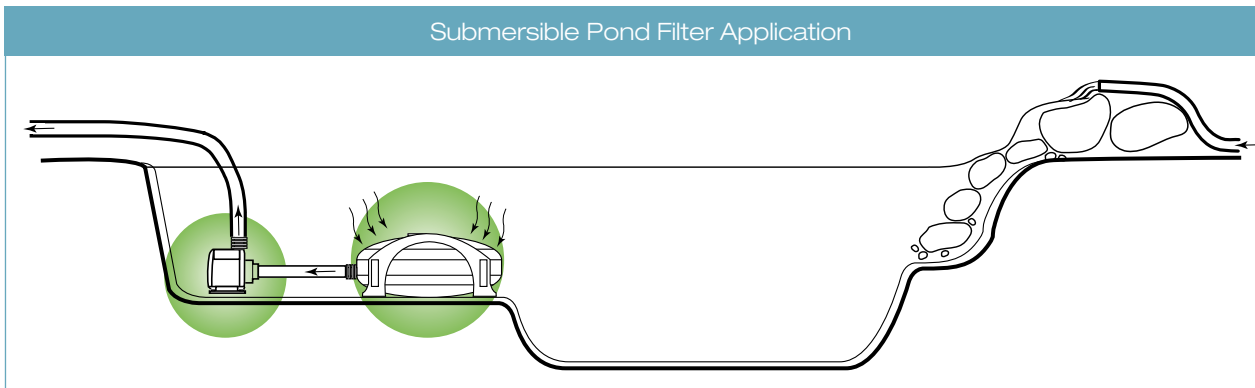

FITTINGS INCLUDED

3 x 3/4", 1", 1 1/4"

Multi-Hose Adapters

Waterfall Spillway



Waterfall Spillway #77000

Packaged Weight: 9 lb

The Waterfall Spillway is a cost-effective solution to create the starting point of a beautiful waterfall and stream.

- Creates smooth, consistent, leak-free water flow
- The durable design makes it easy to disguise by allowing soil, rocks, or logs to be placed directly on top of the unit
- Ideal for starting waterfalls on Pondless® Waterfall systems, where, due to the absence of fish, biological filters aren't necessary
- Excellent choice for designing additional waterfalls and streams onto new or existing ponds that already have a biological filter
- Build behind hardscape walls to provide a more formal waterfall design
- Use multiple Waterfall Spillways to design larger, more complex waterfall configurations



Features of the Waterfall Spillway

- ① Durable design allows boulders, logs, or other creative landscape material to be set directly on top, helping to camouflage the spillway into the surrounding landscape
- ② Watertight connection using the fitting on the back of the Waterfall Spillway
- ③ Wide 22" spillway handles flow rates up to 7,500 GPH
- ④ Internal barriers provide a smooth-flowing waterfall

Waterfall Spillway Application

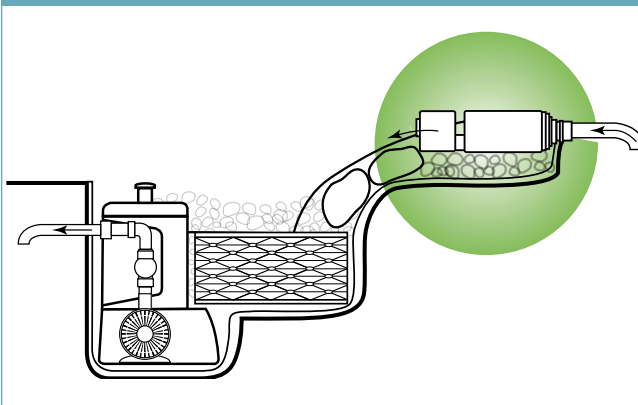

Waterfall Spillway Specification Chart

Spillway Width	22"
Bulkhead Port	Single 2"
Fittings Included	2" PVC slip, 1.5" barbed hose fitting and pre-installed bulkhead
Maximum Flow Rate	7,500 GPH / 28,000 LPH
Spillway Dimensions	17.5"L x 24"W x 5"H

IonGen™ System G2

The IonGen™ System G2 electronic water clarifier allows you to spend your time relaxing next to your water feature instead of maintaining it! The IonGen™ effectively removes debris without the use of traditional liquid chemicals and is designed with a microprocessor that sends a signal to its ion producing probe, helping to control debris throughout the entire water feature.

- Simple to install
- Compatible with water containing fish and plants
- Energy efficient
- Treats ponds up to 25,000 gallons
- Complete with electronic control panel, outdoor-rated transformer, flow chamber, probe, probe fittings, probe holder, copper test kit, alkalinity test kit and owner's manual



IonGen™ System G2

#95012

Packaged Weight: 3.3 lb

Packaged Dimensions: 14"L x 4.5"W x 18"H



Features of the IonGen™ System G2

- ① Weatherproof control panel
- ② Easy-to-read digital display
- ③ Indicator notifies you when the probe needs to be replaced
- ④ Adjustable ionization level
- ⑤ Durable quick-connect electrical connections
- ⑥ Tool-free probe installation
- ⑦ Angled probe helps deflect debris and reduce clogging
- ⑧ 2" threaded inlet and outlet

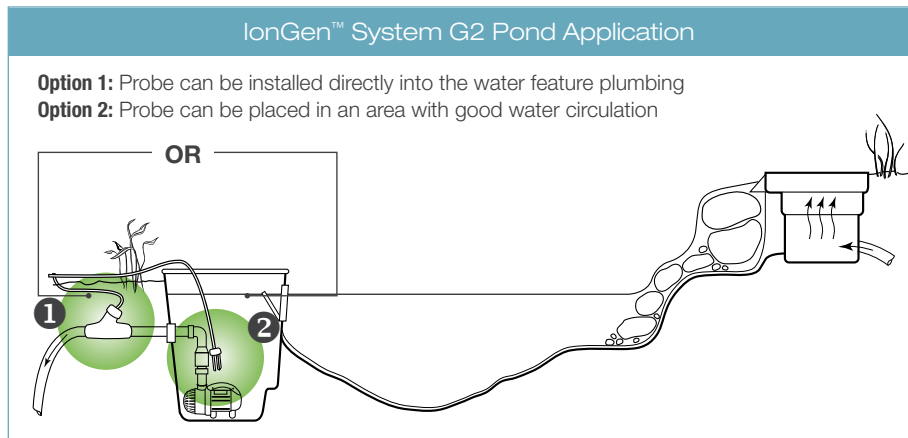

FITTINGS INCLUDED

2 x 1", 1/4", 1/2" Multi-Hose Fitting,
2 x 2" PVC Slip Fitting



IonGen™ G2 Probe Holder
#95077

Packaged Weight: 0.5 lb

- Allows for installation of G2 Probe without flow chamber
- Can be used in a filter, such as a skimmer or Pondless® Waterfall Vault
- Straps onto any pipe or check valve from 1–4 inches in diameter



IonGen™ Probe for the G2 System
#95016

Packaged Weight: 0.5 lb

- For 2nd generation flow chamber
- Includes 5 foot quick-connect cable



IonGen™ Probe for the G1.5 System
#95072

Packaged Weight: 1 lb

- For 1st generation PVC tee-style flow chamber and the G2 control panel
- Includes 5 foot quick-connect cable



CU/Copper Test Kit
#96020

Packaged Weight: 0.2 lb

- Measures residual copper
- 25 tests per kit



KH/Alkalinity Test Kit
#96019

Packaged Weight: 0.2 lb

- Measures KH/alkalinity
- 60 tests per kit

UltraKlear® UV Clarifier

The Aquascape UltraKlear® UV Clarifier uses a technologically-advanced T5 high-output UVC bulb to eliminate 'green water.' The Aquascape UltraKlear® UV Clarifier features a swirl sleeve which directs the water around the UV bulb, maximizing contact time and increasing UV efficiency up to 50% over traditional UV clarifiers.

- Effectively clears unsightly green (pea soup) water algae blooms
- Simple and easy to use, install, and maintain
- Features a swirl sleeve to optimize UV efficiency
- High-output UV bulb maximizes performance
- Easy-to-remove bulb and quartz sleeve
- Can be mounted horizontally or vertically



UltraKlear® 1000 UV Clarifier
#95036

Packaged Weight: 6.5 lb
Dimensions: 23.5"L x 5.5"W x 3.75"H



UltraKlear® 2500 UV Clarifier
#95037

Packaged Weight: 8 lb
Dimensions: 33.5"L x 5.5"W x 3.75"H



UltraKlear® 5000 UV Clarifier
#95038

Packaged Weight: 10 lb
Dimensions: 43"L x 5.5"W x 3.75"H

Features of the UltraKlear® UV Clarifier

- ① Narrow contact chamber increases effectiveness of UV light
- ② Internal sleeve increases contact time, thus increasing efficiency
- ③ Additional side water flow output allows for easier installation
- ④ High-output (HO) T5 bulb maximizes effectiveness
- ⑤ On/off indicator provides quick verification
- ⑥ Mounting brackets make it simple to attach the unit to a vertical surface
- ⑦ High-quality quartz sleeve maximizes bulb output
- ⑧ Mechanical safety switch automatically turns off bulb when the ballast/ bulb is removed
- ⑨ Electronic ballast ensures optimum wattage and bulb output



UltraKlear® UV Clarifier Product Specification Chart

Model	UltraKlear 1000 UV Clarifier	UltraKlear 2500 UV Clarifier	UltraKlear 5000 UV Clarifier
Average Pond Size Recommendation	1,000 gal / 3,800 L	2,500 gal / 9,500 L	5,000 gal / 19,000 L
Maximum Flow Rate	500 GPH / 1,900 LPH	1,000 GPH / 3,800 LPH	1,500 GPH / 5,700 LPH
UV Wattage	14	28	55
Power Cord Length	20'	20'	20'
Discharge Hose Diameter	1", 1.25", 1.5"	1", 1.25", 1.5"	1", 1.25", 1.5"
Dimensions	23.5"L x 5.5"W x 3.75"H	33.5"L x 5.5"W x 3.75"H	43"L x 5.5"W x 3.75"H
Warranty	3-Year Limited	3-Year Limited	3-Year Limited



FITTINGS INCLUDED

2 x 1½" Rotational Ball Output, 4 x 1", 1¼", 1½" Multi-Hose Fittings, 2 x Elbows, 2 x Adapters, 2 x Mounting Brackets

Additional Pond Filters

These filters are ideal for smaller ponds, including preformed ponds or container water gardens. These filters can be easily incorporated into existing ponds, and are ideal for use with Aquascape Ultra, EcoWave, AquaSurge®, or AquaForce® Pumps.



Pond Waterfall Filter
#77020

Packaged Weight: 11 lb

- Provides efficient mechanical and biological filtration for ponds up to 1,000 gallons
- Includes rigid filter mat and biological filter media net



Features of the Pond Waterfall Filter

- ① Durable, circular construction ensures maximum strength
- ② Filter mat provides ideal mechanical and biological filtration
- ③ Included filter media net holds biological filter media (filter media sold separately)
- ④ Filter rack provides support for filter media
- ⑤ Fitting accepts 1", 1¼", and 1½" pipe sizes



Small Pond Filter Urn
#77006

Packaged Weight: 16.1 lb

Dimensions: 20"L x 11"W x 11"H



Features of the Pond Filter Urn

- ① Removable filter lid allows easy access for cleaning
- ② Decorative filter housing can be easily incorporated into any setting
- ③ Inlet hose accommodates most small pumps
- ④ Mechanical filtration removes debris
- ⑤ Ceramic filtration rings provide bacteria with a large surface area for colonization



Large Pond Filter Urn
#77011

Packaged Weight: 25 lb

Dimensions: 28"L x 15.5"W x 15.5"H

Additional Pond Filters Product Specification Chart

	Small Pond Filter Urn	Large Pond Filter Urn	Pond Waterfall Filter
Maximum Flow Rate	400 GPH	1,100 GPH	5,000 GPH
Pond Volume	500 gal	1,500 gal	1,000 gal
Inlet Fitting Dimensions	0.5"	0.75"	1", 1.25", 1.5"
Filter Dimensions	20"L x 11"W x 11"H	28"L x 15.5"W x 15.5"H	20"L x 15"W x 12.5"H

AquaBlox® Water Storage Modules

AquaBlox® Water Storage Modules provide an efficient way to maximize water storage capacity in Pondless® Waterfall reservoirs, Rainwater Harvesting Systems, and permeable paver applications.

- Over 3 times more water storage capacity than gravel
- Holds approximately 7.4 gallons of water per cubic foot, compared to gravel, which holds approximately 2.2 gallons of water per cubic foot
- Extra water storage capacity means less time topping off reservoir due to evaporation
- Easier to clean and less prone to clogging than traditional gravel basins
- Allows for a smaller reservoir footprint
- Less labor required to excavate and move gravel
- Uses less liner and geotextile underlayment than reservoirs constructed with gravel



AquaBlox® Small Water Storage Module
#29491

Packaged Weight: 11 lb
Dimensions: 26.5"L x 16"W x 9.5"H



AquaBlox® Large Water Storage Module
#29492

Packaged Weight: 16 lb
Dimensions: 26.5"L x 16"W x 17.5"H

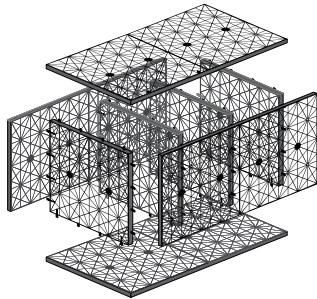

Takes one minute to assemble!

AquaBlox® are assembled on-site, making transportation and installation extremely efficient

Waterfall Spillway Application

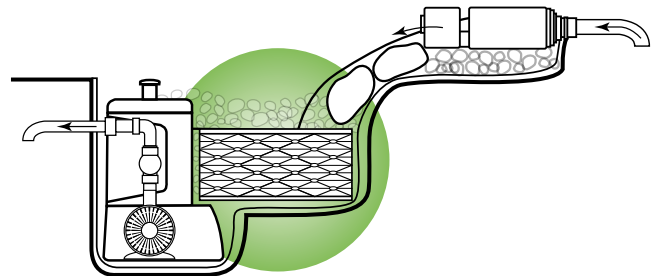

AquaBlox® Water Storage Modules Product Specification Chart

	Small	Large
Dimensions	26.5"L x 16"W x 9.5"H	26.5"L x 16"W x 17.5"H
Volume	17 gal / 64.35 L	32 gal / 121.13 L
Load Bearing Weights	5,472 lb/sq. ft.	5,472 lb/sq. ft.

Snorkel® and Centipede® Wetland Filter

Our patented Snorkel® Vault and Centipede® Module were specifically designed to tackle the common issues that plague large scale water features. They are modular in design, allowing builders and designers the flexibility to expand the system to meet their needs.

- Highly effective at removing sediment (suspended solids) from ponds
- Easily access collected sediment with the Snorkel® Vault, reducing the need for costly and invasive dredging
- Improves water clarity
- Works on earth bottom and liner membrane ponds
- Reduces the physical and chemical maintenance that goes along with removing algae
- Easily retrofitted onto existing ponds



Large Snorkel® Vault and Cap
#29064

Packaged Weight: 27 lb

- Allows pump to be dropped in for easy cleaning
- Four ports for Large Centipede® Module attachment



Large Snorkel® Vault Extension
#29068

Packaged Weight: 10 lb

- For use when creating deeper basins or using the AquascapePRO 10,000 or 12-PN pump



Large Centipede® Module
#29065

Packaged Weight: 29 lb

- Sits at the lowest point in the filter
- Ensures maximum water distribution and allows for efficient sediment removal during cleaning
- Modular design

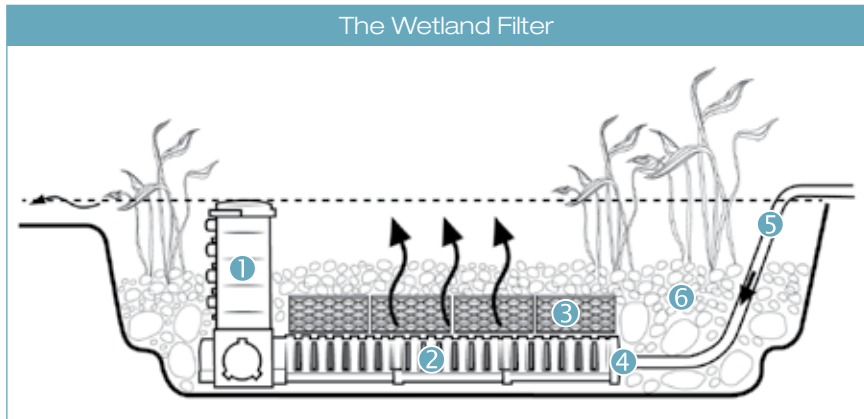

- ① Snorkel® Vault
- ② Large Centipede® Module
- ③ AquaBlox®
- ④ Rubber Coupling
- ⑤ Flex PVC Piping
- ⑥ Rocks and Gravel

Constructed Wetland Filter System Requirements

Pond Size (in sq. ft.)	Filter Size (Avg. 5 1/2' Depth)	Number of Centipede Modules	Number of Snorkel with Extension	Number of Small AquaBlox®	Min. Pump Flow GPH
500	8' x 10'	1	1	16	2,000
1,000	10' x 15'	2	1	32	4,000
2,000	12' x 25'	4	1	64	8,000
5,000	25' x 25'	8	2	128	16,000
7,500	25' x 40'	12	2	192	24,000
10,000	25' x 50'	16	2	256	32,000
15,000	36' x 40'	18	3	288	36,000

Container Water Garden Filter

The Aquascape Container Water Garden Filter is a complete solution for container water gardens or containers with stagnant or non-moving water, including birdbaths and water containers holding pond plants like lotus or waterlilies.

- Provides ideal filtration for container water gardens up to 50 gallons
- Magnetically-driven motor is simple and easy to maintain
- Extremely energy-efficient
- Durable pre-filter water intake design prevents clogging and reduces pump maintenance



Container Water Garden Filter
#77005

Packaged Weight: 0.8 lb
Dimensions: 2"L x 1.5"W x 7"H



Features of the Container Water Garden Filter

- ① Adjustable spray bar adds surface movement and oxygen to the water
- ② Integrated suction cups adhere the filter to surfaces like the shelf in the Aquascape Patio Pond
- ③ Mechanical and biological filter sponge and filter carbon reduces maintenance and provides excellent filtration
- ④ Protective pump cage and pre-filter prevents debris from clogging or damaging pump

BioBalls Biological Filter Media

Aquascape BioBalls provide a textured surface area (19 square inches per BioBall) for beneficial bacteria to colonize and grow, keeping pond water clean, clear, and healthy. BioBalls are easy to clean, long lasting, and lightweight, making them the ideal filtration media for use in biological filters.



BioBalls Biological Filter Media
100 Count
#98464

Packaged Weight: 2.8 lb
Packaged Dimensions: 8"L x 8"W x 6.5"H

- 100 BioBalls
- 1.5" diameter
- Media net included



BioBalls Biological Filter Media
1,000 Count
#56014

Packaged Weight: 23.3 lb
Packaged Dimensions: 18"L x 12"W x 14"H

- 1,000 BioBalls
- 1.5" diameter
- Media nets sold separately



BioBalls Filter Media Net
#29069

Packaged Weight: 0.4 lb
Packaged Dimensions: 7.25"L x 1"W x 10.5"H

Filter Rolls and Mats



Coarse Filter Media Roll
1.25" Thick
#99321

Packaged Weight: 8.4 lb
10'L x 56"W



Coarse Filter Media Roll
2" Thick
#99323

Packaged Weight: 11.9 lb
10'L x 56"W



Dense Filter Media Roll
1" Thick
#99325

Packaged Weight: 8.8 lb
10'L x 56"W



Low Density
Rigid Filter Mat
#80003

Packaged Weight: 3.1 lb
24"L x 39"W x 1.5" Thick



Medium Density
Rigid Filter Mat
#80004

Packaged Weight: 3.1 lb
24"L x 39"W x 1.5" Thick

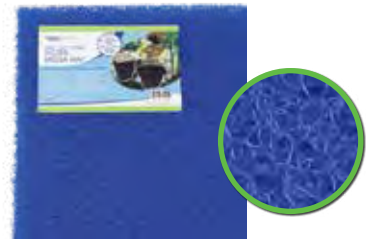

High Density
Rigid Filter Mat
#80005

Packaged Weight: 3.1 lb
24"L x 39"W x 1.5" Thick



Rapid Clear Fine Filter Pads
#80001

Packaged Weight: 0.6 lb
Dimensions: 12"W x 24"L

- Speeds up filtering of flocculated particles
- Enhances water quality
- For best results, use in combination with Rapid Clear Flocculant water treatments



PUMPS

Pumps

Selecting the proper submersible water pump is extremely important in order to achieve optimum performance of your pond or water feature. There are three basic types of water pumps available in the ornamental pond industry: direct-drive, asynchronous, and magnetically-driven pumps (also known as mag-drive). The following section will help you make the right selection. If you have questions about pump selection, please visit our website or contact Aquascape Customer Care.

Direct-Drive

Direct-drive water pumps provide consumers with a high torque, high head height pump option. Direct-drive pumps are generally easier to maintain because of their ability to handle larger solids. It is important to note that these pumps have to be operated within a specific performance curve to optimize lifespan.

Mag-Drive

Mag-drive water pumps are a simple and easy-to-use solution for small water features including decorative fountains and spitters. These pumps are easy to retrofit into existing water features. Mag-drive pumps have only one moving part, making them inexpensive and easy to maintain. Mag-drive pumps are also extremely quiet and energy-efficient.

Asynchronous

Asynchronous water pumps are a hybrid between a direct-drive and mag-drive pump. They have only one moving part, making them less expensive and easy to maintain. This type of pump is extremely energy-efficient, and choosing one over a traditional direct-driven pump often pays for itself quickly in power consumption savings.

AquaSurge® Pond Pumps

AquaSurge® asynchronous pond pumps combine energy-efficient performance, high flow rates, and ease of maintenance, making this pump the perfect choice for pond owners. AquaSurge® pumps are ideal for use in pond skimmers and Pondless® Waterfall Vaults.

- Extremely energy-efficient, saving hundreds of dollars over traditional water pumps
- Asynchronous motor technology provides high torque, trouble-free performance
- Oil-free design prevents pond contamination
- Made for continuous use
- Will not corrode or rust
- Can be used vertically or horizontally
- Plumbing adapter fittings included



AquaSurge® 2000 Pond Pump
#91017

Packaged Weight: 9.3 lb
Packaged Dimensions: 13.25"L x 9"W x 9"H



AquaSurge® 3000 Pond Pump
#91018

Packaged Weight: 9.7 lb
Packaged Dimensions: 13.25"L x 9"W x 9.5"H



AquaSurge® 4000 Pond Pump
#91019

Packaged Weight: 12.1 lb
Packaged Dimensions: 15"L x 9.25"H x 10.5"H



AquaSurge® 5000 Pond Pump
#91020

Packaged Weight: 13.7 lb
Packaged Dimensions: 15"L x 9.25"W x 11.25"H



AquaSurge® Low Suction Intake Attachment
#91117

Packaged Weight: 1 lb
Allows pump to operate in shallow applications such as the AquaBasin® 45.

NOTE: Not compatible with the AquaSurge® 4000-8000



FITTINGS INCLUDED

2 x 1", 1¼", 1½" Multi-Hose Fittings, 1¼", 1½", 2" Multi-Hose Fitting, 1½", 2" Multi-Hose Fitting, 1½" Rotational Ball Output, 1½" Female Coupler, 1½" Male Coupler

NOTE: multiple fittings included to simplify plumbing connection

AquaSurge® Adjustable Flow Pond Pumps

- Allows you to customize and fine-tune the flow of waterfalls and streams
- Wireless flow control makes it easy to select the right pump for any application
- Pump can be adjusted or turned on or off with remote
- Allows waterfalls to be adjusted or turned on and off when desired



AquaSurge® 2000–4000
Adjustable Flow Pond Pump
#45009

Packaged Weight: 10.5 lb
Packaged Dimensions: 15"L x 9.5"W x 10.5"H



AquaSurge® 4000–8000
Adjustable Flow Pond Pump
#45010

Packaged Weight: 13 lb
Packaged Dimensions: 15"L x 9.5"W x 10.5"H



FITTINGS INCLUDED

2 x 1", 1/4", 1/2" Multi-Hose Fittings, 1/4", 1/2", 2" Multi-Hose Fitting, 1/2", 2" Multi-Hose Fitting, 1/2" Rotational Ball Output, 1/2" Female Coupler, 1/2" Male Coupler

NOTE: multiple fittings included to simplify plumbing connection

Features of the AquaSurge® Pond Pumps

- ① Compact size makes it the perfect pump for pond skimmers
- ② Built-in cord strain relief protects the cord from being damaged
- ③ Asynchronous motor technology makes this pump more powerful than traditional magnetically-driven pond pumps
- ④ Unique ceramic shaft with cooling port prevents the pump from overheating
- ⑤ Simple and secure threaded disconnect allows the pump to be easily removed from the skimmer for maintenance or winterization
- ⑥ Integrated rubber feet prevent noise and vibration
- ⑦ The rotational ball output allows the discharge position to be easily adjusted
- ⑧ Included pump stand allows for vertical positioning

REMOTE INCLUDED

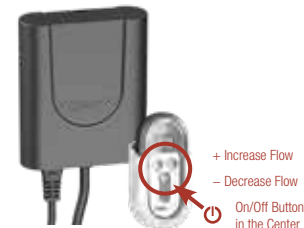

Adjustable Flow Pond Pump Remote and Receiver

Features include:

- Numeric flow indicator
- Includes remote control holster for quick and easy mounting
- Receiver includes mounting hardware
- Sleek and ergonomic design

NOTE: Only compatible with AquaForce® and AquaSurge® Adjustable Flow Pond Pumps

AquaSurge® Pond Pumps

AquaSurge® Pond and Pondless® Waterfall Application



AquaSurge® and AquaSurge® Adjustable Flow Pond Pump Specifications

Model	2000	3000	4000	5000	2000-4000	4000-8000
Maximum Flow Rate (GPH)	2,193	3,196	3,947	5,284	3,947	7,793
Maximum Head Height	12.5'	15'	18.5'	24'	18.5'	28'
Motor Type	Asynchronous	Asynchronous	Asynchronous	Asynchronous	Asynchronous	Asynchronous
Wattage	160	165	215	360	180 - 215*	500 - 660*
Amperage	1.3	1.4	1.82	3	1.82	5.5
Power Cord Length	20'	20'	20'	20'	20'	20'
Pump Discharge Diameter	1.5" MPT	1.5" MPT	1.5" MPT	1.5" MPT	1.5" MPT	1.5" MPT
Dimensions Pump	12"L x 5.5"W x 7"H	12"L x 5.5"W x 7"H	14"L x 6"W x 7.5"H	14"L x 6"W x 7.5"H	14"L x 6"W x 7.5"H	14"L x 6"W x 7.5"H
Dimensions Remote	—	—	—	—	2.5"L x 1.5"W x .75"H	2.5"L x 1.5"W x .75"H
Dimensions Receiver	—	—	—	—	4.5"L x 1.5"W x 5"H	4.5"L x 1.5"W x 5"H
Warranty	3-Year Limited	3-Year Limited	3-Year Limited	3-Year Limited	3-Year Limited	3-Year Limited

*Wattage range depending on remote control flow setting.

AquaSurge® and AquaSurge® Adjustable Flow Pond Pump Flow Chart

Model	Max Head Height	Application Head Height													
		0'	5'	10'	15'	20'	25'	30'	35'	40'	45'	50'	55'		
AquaSurge® 2000	12.5'	2193	1850	1465	0	GPH									
AquaSurge® 3000	15'	3196	2700	2350	0	GPH									
AquaSurge® 4000	18.5'	3947	3750	3350	2250	0	GPH								
AquaSurge® 5000	24'	5284	5000	4750	3250	1750	0	GPH							
AquaSurge® 2000-4000	18.5'	3947	3750	3350	2250	0	GPH								
AquaSurge® 4000-8000	28'	7793	7350	7000	5850	4300	2000	0	GPH						

BEST Operating Zone **MAXIMUM Operating Zone**

AquaSurge® and AquaSurge® Adjustable Flow Pond Pump Pipe Diameter Chart

Model	1/2"	3/4"	1"	1.25"	1.5"	2"	3"
AquaSurge® Pond Pumps 2000, 3000, 4000, 5000							
AquaSurge® 2000-4000 Adjustable Flow Pond Pump							
AquaSurge® 4000-8000 Adjustable Flow Pond Pump							

Acceptable Pipe Diameter **Optimum Pipe Diameter**

PL and PN Solids-Handling Pond Pumps

The PL and PN series pumps are known for durability, performance, and value. The direct-drive motor and semi-vortex impeller design enables the pump to efficiently and effectively handle solids, resulting in less maintenance and trouble-free performance. The built-in thermal overload protects the pump from damage if operated in low water conditions.

- Ideal for use in pond skimmer filters and the Pondless® Waterfall Vault
- Semi-vortex solids-handling impeller reduces clogging and decreases maintenance
- Continuous duty motor operates at lower temperatures to extend pump life
- Constructed of stainless steel and composite resin for strength and corrosion resistance



3-PL 3000
Solids-Handling Pond Pump
#29975

Packaged Weight: 17 lb
Packaged Dimensions: 13"L x 9.75"W x 9.5"H



5-PL 5000
Solids-Handling Pond Pump
#29976

Packaged Weight: 19 lb
Packaged Dimensions: 9.75"L x 15.5"W x 9.5"H



9-PL 7000
Solids-Handling Pond Pump
#29977

Packaged Weight: 23 lb
Packaged Dimensions: 9.75"L x 15.5"W x 9.5"H



8-PN 5500
Solids-Handling Pond Pump
#29495

Packaged Weight: 29 lb
Packaged Dimensions: 17.25"L x 10.25"W x 9"H



12-PN 10000
Solids-Handling Pond Pump
#30391

Packaged Weight: 31.9 lb
Packaged Dimensions: 9"L x 12.5"W x 17.75"H

PL and PN Solids-Handling Pond Pumps

PL and PN Solids-Handling Pond Pump Specifications					
Model	3-PL	5-PL	9-PL	8-PN	12-PN
Maximum Flow Rate (GPH)	3,000	5,300	7,300	5,548	10,000
Maximum Head Height	14'	23'	35'	56'	23'
Motor Type	Direct Drive	Direct Drive	Direct Drive	Direct Drive	Direct Drive
Wattage	320	620	1,000	1,000	900
Amperage	3.1	5.6	8.6	9.1	9.1
Power Cord Length	20'	20'	20'	20'	20'
Pump Discharge Diameter	2"	2"	2"	2"	3"
Dimensions	12.2"L x 5.6"W x 7.1"H	13.2"L x 5.9"W x 7.3"H	14"L x 5.9"W x 7.3"H	9.3"L x 6.4"W x 15"H	11.7"L x 7.7"W x 15.1"H
Warranty	2-Year Limited	2-Year Limited	2-Year Limited	2-Year Limited	2-Year Limited

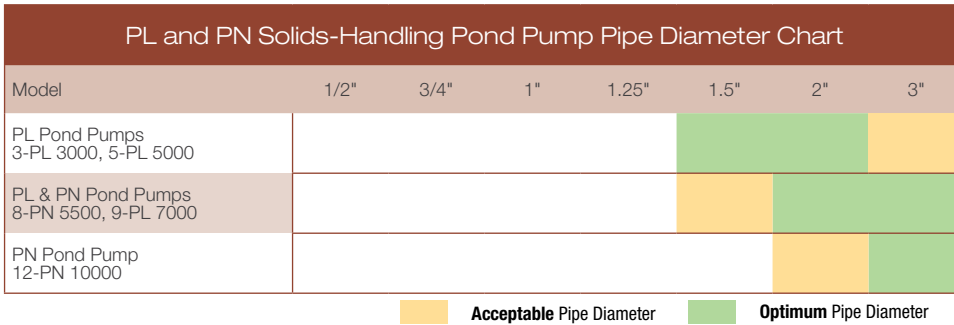
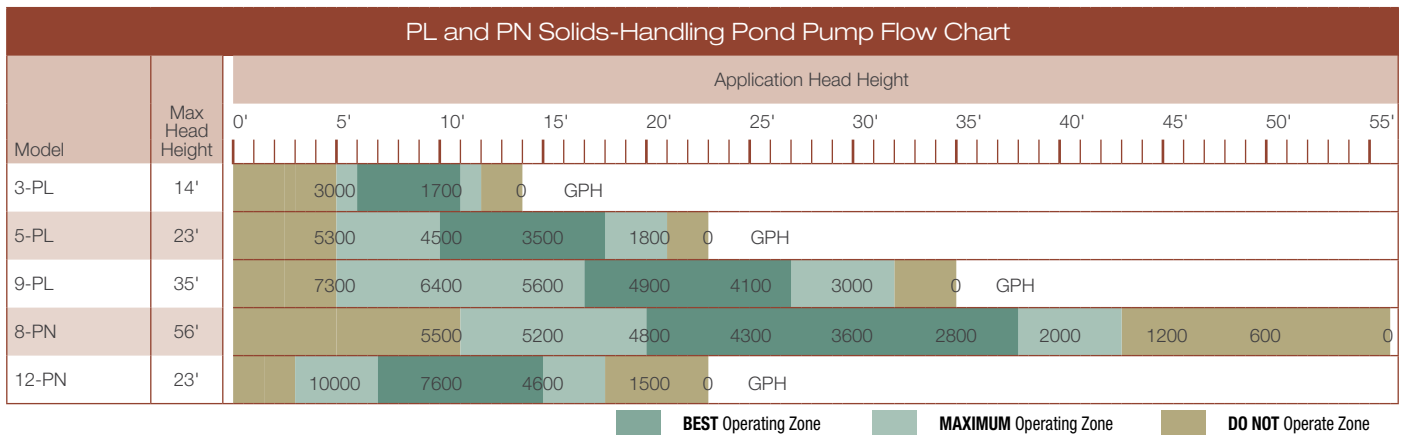

AquascapePRO® Pond Pumps

AquascapePRO® Pond Pumps are ideal for use in pond skimmer and waterfall filter systems, as well as Pondless® Waterfall Vaults. Pond pumps from the AquascapePRO line are quiet and low maintenance. These pumps feature durable, stainless steel construction along with rubber feet to reduce vibration. These direct-drive pumps are ideal for high head heights.

- Ideal for use in pond skimmer filters and the Pondless® Waterfall Vault
- Ideal for high head heights
- Direct-drive motor reduces clogging and decreases maintenance
- Constructed of stainless steel and composite resin for strength and corrosion resistance



AquascapePRO® 3000 Pond Pump
#20002

Packaged Weight: 16 lb
Packaged Dimensions: 14.25"L x 8"W x 8"H



AquascapePRO® 4500 Pond Pump
#20003

Packaged Weight: 17 lb
Packaged Dimensions: 14.75"L x 9.25"W x 9"H



AquascapePRO® 7500 Pond Pump
#20004

Packaged Weight: 22 lb
Packaged Dimensions: 14.75"L x 9.25"W x 9"H



AquascapePRO® 10000 Pond Pump
#20006

Packaged Weight: 39 lb
Packaged Dimensions: 13.5"L x 12"W x 18.75"H

AquascapePRO® Pond Pumps

AquascapePRO® Pond Pump Specifications				
Model	3000	4500	7500	10,000
Maximum Flow Rate (GPH)	2,900	4,500	6,700	10,600
Maximum Head Height	20'	33'	42'	28'
Motor Type	Direct Drive	Direct Drive	Direct Drive	Direct Drive
Wattage	280	625	1,200	1,240
Amperage	2.6	5.4	10	11
Power Cord Length	20'	20'	20'	20'
Pump Discharge Diameter	2"	2"	2"	3"
Dimensions Pump	12"L x 6"W x 7"H	13"L x 6.5"W x 7"H	13"L x 6.5"W x 7"H	12.5"L x 9"W x 17"H
Warranty	2-Year Limited	2-Year Limited	2-Year Limited	2-Year Limited

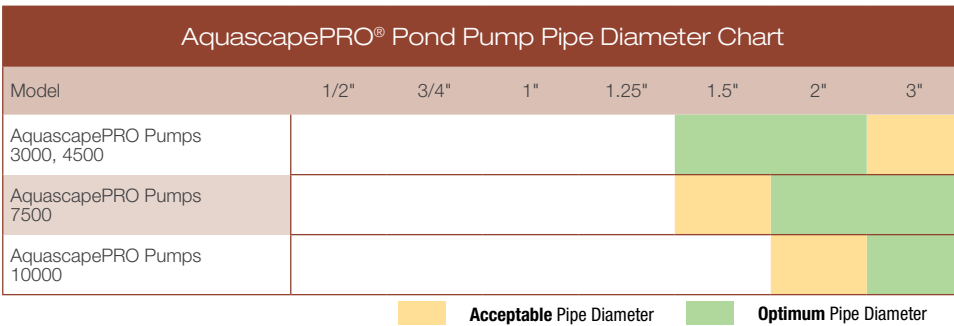
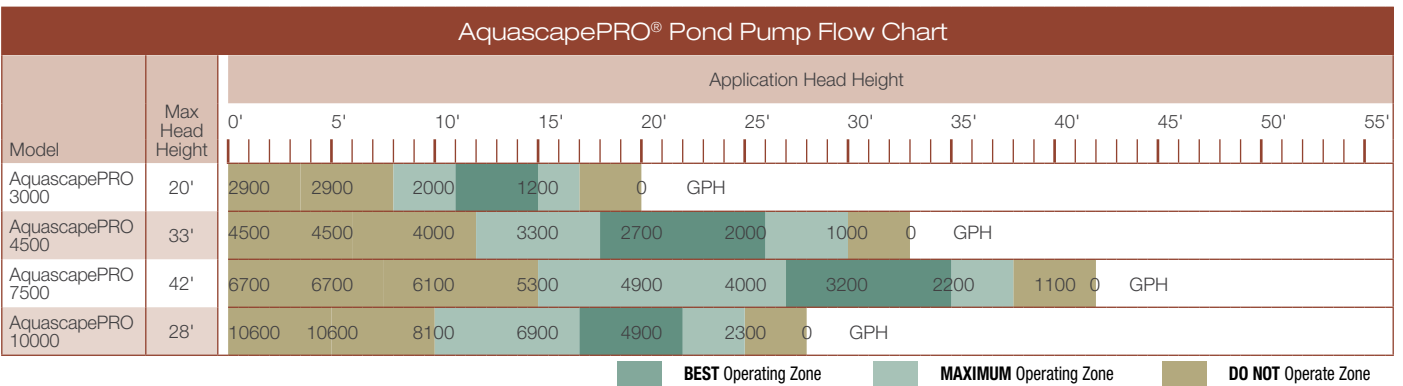

AquaForce® Solids-Handling Pond Pumps

AquaForce® asynchronous, solids-handling waterfall and filter pumps combine energy-efficient performance, high flow rates, and ease of maintenance, making this pump the ideal choice for discerning pond owners. The AquaForce® protective pre-filter cage allows the pump to be placed directly into the pond. AquaForce® pumps are able to pump solids up to ¼" inch in diameter, making it ideal for use with external pressure filters or Aquascape waterfall filter systems.

- Extremely energy-efficient, resulting in considerable annual energy savings
- Asynchronous motor technology provides high torque, trouble-free performance
- Handles solids up to ¼" in diameter
- Easy to maintain
- Durable pre-filter cage design prevents clogging and reduces pump maintenance
- Oil-free design prevents pond contamination
- Plumbing adapter fittings included
- Provides years of trouble-free operation
- Can also be used as a de-icer pump during cold weather months



AquaForce® 1000 Solids-Handling Pond Pump

#91011

Packaged Weight: 10.6 lb
Packaged Dimensions: 14.25"L x 9"W x 14.75"H



AquaForce® 1800 Solids-Handling Pond Pump

#91112

Packaged Weight: 9.75 lb
Packaged Dimensions: 14"L x 9"W x 15.25"H



AquaForce® 2700 Solids-Handling Pond Pump

#91012

Packaged Weight: 11.5 lb
Packaged Dimensions: 14.25"L x 9"W x 15.75"H



AquaForce® 3600 Solids-Handling Pond Pump

#91113

Packaged Weight: 11.75 lb
Packaged Dimensions: 14"L x 9"W x 16.25"H



AquaForce® 5200 Solids-Handling Pond Pump

#91013

Packaged Weight: 15.4 lb
Packaged Dimensions: 14.25"L x 9"W x 16.75"H

AquaForce® Adjustable Flow Solids-Handling Pond Pumps

- Allows you to customize and fine-tune the flow of waterfalls and streams
- Ability to adjust the flow makes it easy to select the right pump for any application
- Pump can be turned on or off with remote
- Each remote and receiver are paired together with a unique frequency



AquaForce® 4000–8000 Adjustable Flow Solids-Handling Pond Pump #91104

Packaged Weight: 16.5 lb
Packaged Dimensions: 14"L x 9"W x 18.75"H



Features of the AquaForce® Pond Pumps

- ① Protective pump cage prevents large debris from clogging or damaging pump, reducing maintenance
- ② Large cage openings allow solids to be easily passed and filtered, preventing the pump from being clogged or damaged
- ③ Asynchronous motor technology makes this pump more powerful than traditional magnetically-driven or "mag-drive" pond pumps
- ④ The simple and secure threaded disconnect allows the pump to be easily removed from the pond for maintenance or winterization without removing hose clamps or plumbing assembly
- ⑤ The wide, flat shape of the pump cage makes it stable and easy to place in the pond
- ⑥ The rotational ball output allows the pump discharge position to be easily adjusted, making this pump ideal for all shapes and sizes of ponds

REMOTE INCLUDED

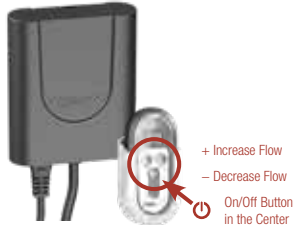

Adjustable Flow Pond Pump Remote and Receiver

Features include:

- Numeric flow indicator
- Includes remote control holster for quick and easy mounting
- Receiver includes mounting hardware
- Sleek and ergonomic design

NOTE: Only compatible with AquaForce® and AquaSurge® Adjustable Flow Pond Pumps

AquaForce® Pond Application

The AquaForce® protective pre-filter cage allows the pump to be placed directly into the pond.

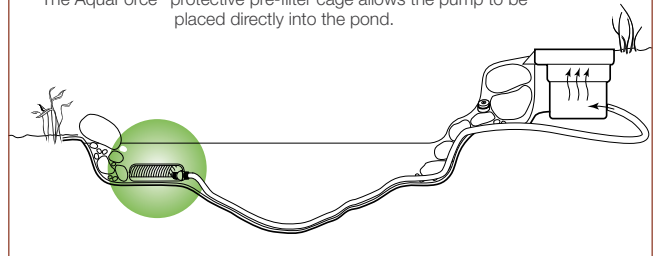

AquaForce® Solids-Handling Pond Pump Pipe Diameter Chart

Model	1/2"	3/4"	1"	1.25"	1.5"	2"	3"
AquaForce Pond Pumps 1000, 1800, 2700, 3600, 5200			Acceptable	Optimum	Optimum	Optimum	Acceptable
AquaForce Adjustable Flow Pond Pumps 4000–8000					Acceptable	Optimum	Optimum

Acceptable Pipe Diameter Optimum Pipe Diameter

AquaForce® Solids-Handling Pond Pumps

AquaForce® and AquaForce® Adjustable Flow Pond Pump Specifications

Model	1000	1800	2700	3600	5200	4000-8000
Maximum Flow Rate (GPH)	1,070	2,149	2,695	3,868	5,284	7,793
Maximum Head Height	10'	16.5'	14'	18'	24'	28'
Motor Type	Asynchronous	Asynchronous	Asynchronous	Asynchronous	Asynchronous	Asynchronous
Wattage	55	160	147	215	360	500-660*
Amperage	0.51	1.33	1.25	1.8	3	5.5
Power Cord Length	25'	25'	25'	25'	25'	20'
Pump Discharge Diameter	1.5" MPT	1.5" MPT	1.5" MPT	1.5" MPT	1.5" MPT	1.5" MPT
Dimensions Pump	14"L x 14"W x 6.5"H	14"L x 14"W x 6.5"H	14"L x 14"W x 6.5"H	14"L x 14"W x 6.5"H	14"L x 14"W x 6.5"H	14"L x 14"W x 6.5"H
Dimensions Remote	—	—	—	—	—	2.5" L x 1.5" W x .75" H
Dimensions Receiver	—	—	—	—	—	4.5" L x 1.5" W x 5" H
Warranty	3-Year Limited	3-Year Limited	3-Year Limited	3-Year Limited	3-Year Limited	3-Year Limited

* Wattage range depending on remote control flow setting.

AquaForce® and AquaForce® Adjustable Flow Pond Pump Flow Chart

Model	Max Head Height	Application Head Height											
		0'	5'	10'	15'	20'	25'	30'	35'	40'	45'	50'	55'
AquaForce® 1000	10'	1070	850	0	0	0	0	0	0	0	0	0	0
AquaForce® 1800	16.5'	2149	1806	1320	260	0	0	0	0	0	0	0	0
AquaForce® 2700	14'	2695	2425	1840	0	0	0	0	0	0	0	0	0
AquaForce® 3600	18'	3868	3613	3254	2100	0	0	0	0	0	0	0	0
AquaForce® 5200	24'	5284	5116	4250	3186	1500	0	0	0	0	0	0	0
AquaForce® 4000-8000	28'	7794	7150	6440	5320	3950	1800	0	0	0	0	0	0

 BEST Operating Zone  MAXIMUM Operating Zone

Pond Cleanout and Pump Maintenance



Cleanout Pump
#45033

Packaged Weight: 25 lb

- Great for pond cleanouts and installation wash-downs
- 4,200 gallon per hour for fast pump-outs
- Pumps water down to ¼" off the bottom



Cleanout Pump Discharge Hose 50'
#48019

Packaged Weight: 14.75 lb

- Heavy-duty cleanout discharge hose engineered for flexibility and optimal flow
- Swivel cuff fitting prevents kinking or tangling for easy movement around the water feature

NEW



Pump Cleaner Maintenance Solution — 8 oz
#91143

Packaged Weight: 0.6 lb

- Quickly cleans pond, fountain, and waterfall pumps to keep them operating properly
- Uses cutting-edge cleaning compounds to remove scale and bio-film to restore pump

AquaJet® Pond Pumps

AquaJet® Pond Pumps provide a stunning water fountain with the choice of three included fountain heads and an integrated diverter valve to supply water to a small waterfall, external filters, or spitting ornaments.

- Extremely energy-efficient, resulting in considerable annual energy savings
- Mag-drive motor technology is easy to maintain
- Durable pre-filter cage design prevents clogging and reduces pump maintenance



AquaJet® 600 Pond Pump
#91014

Packaged Weight: 5.5 lb
Packaged Dimensions: 13.25"L x 8.75"W x 14.25"H



AquaJet® 1300 Pond Pump
#91015

Packaged Weight: 8.8 lb
Packaged Dimensions: 13.25"L x 8.75"W x 15"H



AquaJet® 2000 Pond Pump
#91016

Packaged Weight: 9.7 lb
Packaged Dimensions: 13.25"L x 8.75"W x 15.75"H



Features of the AquaJet® Pond Pumps

- Adjustable riser stem allows for easy height adjustment from 10 to 20 inches
- Adjustable diverter and flow control
- Rotational riser stem fitting allows for simple leveling of fountain heads
- Protective pump cage prevents debris from clogging or damaging pump, thereby reducing maintenance
- Mag-drive motor technology makes this pump energy-efficient and simple to maintain
- Fine cage openings prevents fountain heads from becoming clogged
- Pump cage clips make it easy to perform pump maintenance or remove debris

AquaJet® Pond Pump Specifications

Model	600	1300	2000
Average Pond Size Recommendation	1,200 gal	1,300 gal	2,000 gal
Maximum Fountain Height (Daisy Fountain)	up to 47"	up to 62"	up to 65"
Motor Type	Mag-drive	Mag-drive	Mag-drive
Wattage	33	110	250
Amperage	0.55	1.00	2.60
Power Cord Length	25'	25'	25'
Discharge Hose Diameter	with nozzle fountain heads	with nozzle fountain heads	with nozzle fountain heads
Discharge Hose Diameter on Diverter	0.5", 0.75"	0.5", 0.75"	0.5", 0.75", 1"
Dimensions	12"L x 12"W x 6"H	12"L x 12"W x 6"H	12"L x 12"W x 6"H
Warranty	3-Year Limited	3-Year Limited	3-Year Limited

AquaJet® Pond Pump Flow Chart

Model	Max Head Height	Application Head Height				
		0'	5'	10'	15'	20'
AquaJet® 600 Pump	7.5'	525	300	0	GPH	
AquaJet® 1300 Pump	13.5'	1350	1050	625	0	GPH
AquaJet® 2000 Pump	20'	2000	1800	1525	1075	0 GPH

BEST Operating Zone **MAXIMUM Operating Zone**



FITTINGS INCLUDED

AquaJet® Foaming Jet, Waterbell, Daisy, Riser Stems, Multi-Hose Fitting, Diverter Valve

EcoWave™ Pond Pumps

EcoWave™ Pond Pumps are magnetically-driven (mag-drive) pond and waterfall pumps developed to provide extremely high flow rates. The internal, smart mag-drive motor technology and vortex style impeller allows these pumps to push an incredible amount of water with an electrical efficiency unmatched by other pumps with similar flow rates. EcoWave Pond Pumps are ideal for use in pond skimmers and Pondless® Waterfall Vault applications with lower head heights.

- Extremely energy-efficient smart mag-drive technology
- Extremely quiet
- Made for continuous use
- Will not corrode or rust
- Compact design
- Oil-free design prevents pond contamination
- Plumbing adapter fittings included

NEW



EcoWave™ 2000 Pond Pump
#91131

Packaged Weight: 10.25 lb
Dimensions: 11"L x 5.75"W x 7.5"H

NEW



EcoWave™ 3000 Pond Pump
#91132

Packaged Weight: 11.5 lb
Dimensions: 11"L x 5.75"W x 7.5"H

NEW



EcoWave™ 4000 Pond Pump
#91133

Packaged Weight: 13 lb
Dimensions: 11"L x 5.75"W x 7.5"H

NEW



EcoWave™ 5000 Pond Pump
#91134

Packaged Weight: 14 lb
Dimensions: 11"L x 5.75"W x 7.5"H



FITTINGS INCLUDED

2 x 1", 1¼", 1½" Multi-Hose Fittings,
1 x 1½" Rotational Ball Output,
1 x 2" FPT x 1½" MPT, 1 x 1½" Female coupling

EcoWave™ Pond Pumps

EcoWave Pond Pump Specifications				
Model	2000	3000	4000	5000
Maximum Flow Rate (GPH)	2,020	2,960	4,000	5,000
Maximum Head Height	14.4'	17.5'	20'	21'
Motor Type	Mag-Drive	Mag-Drive	Mag-Drive	Mag-Drive
Wattage	65	90	130	150
Amperage	0.54	0.75	1.08	1.25
Power Cord Length	20'	20'	20'	20'
Pump Discharge Diameter	2" MPT	2" MPT	2" MPT	2" MPT
Warranty	3-Year Limited	3-Year Limited	3-Year Limited	3-Year Limited

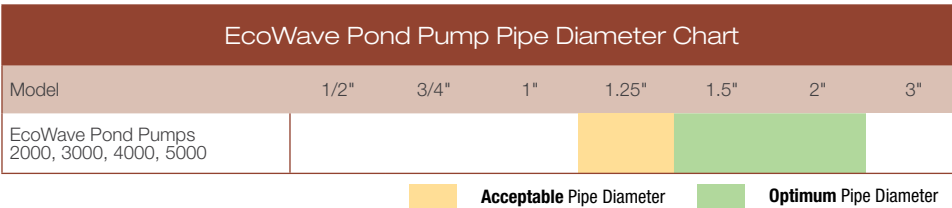
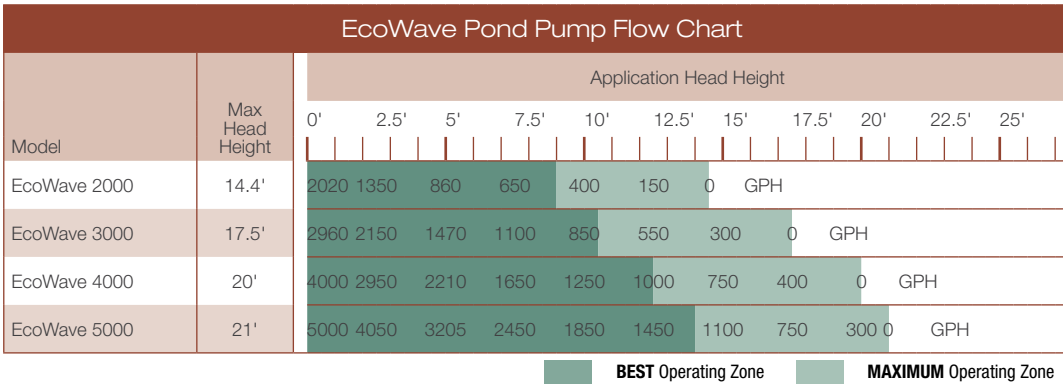

Ultra Water Pumps

Ultra Water Pumps are the complete solution for decorative fountains and spitters. These versatile pumps include a three-way or single valve and multi-size hose connection, making them adaptable to almost any pipe or tubing size.

- Extremely energy-efficient, saving hundreds of dollars over traditional water pumps
- Magnetically-driven motor technology is simple and easy to maintain
- Durable pre-filter cage design protects pump and reduces pump maintenance
- Oil-free design prevents contamination



Ultra 400 Water Pump

#91005

Packaged Weight: 2.9 lb
Packaged Dimensions: 9"L x 5"W x 5"H



Ultra 550 Water Pump

#91006

Packaged Weight: 3.3 lb
Packaged Dimensions: 9"L x 5.25"W x 5.25"H



Ultra 800 Water Pump

#91007

Packaged Weight: 4.4 lb
Packaged Dimensions: 9"L x 6.75"W x 6"H



Ultra 1100 Water Pump

#91008

Packaged Weight: 4.6 lb
Packaged Dimensions: 9.5"L x 6.75"W x 7"H



Ultra 1500 Water Pump

#91009

Packaged Weight: 8.4 lb
Packaged Dimensions: 10.5"L x 8"W x 8"H



Ultra 2000 Water Pump

#91010

Packaged Weight: 8.8 lb
Packaged Dimensions: 10.5"L x 8"W x 9"H



Features of the Ultra Water Pumps

- ① Protective pump strainer cover and sponge filter prevents debris from damaging pump, thereby reducing maintenance and prolonging pump life
- ② Mag-drive motor technology makes this pump energy-efficient and simple to maintain
- ③ The wide, flat base and rubber feet make the pump stable and reduce vibration



FITTINGS INCLUDED IN THE ULTRA 400, 550 AND 800
3/4", 1", 1 1/4" Multi-Hose Adapter, 1/2" MPT Coupling, FPT 90° Elbow 1/2", 1/2" Valve



FITTINGS INCLUDED IN THE ULTRA 1100, 1500 AND 2000
3/4", 1", 1 1/4" Multi-Hose Adapter, 1", 1 1/4", 1 1/2" Multit-Hose Adapter, 3/4" MPT Coupling, FPT 90° Elbow 3/4", 3/4" 3-Way Valve

Ultra Water Pumps

Ultra Water Pump Specifications						
Model	400	550	800	1100	1500	2000
Maximum Flow Rate (GPH)	370	528	793	1,110	1,480	1,982
Maximum Head Height	7.5'	8'	9'	12'	16.5'	20'
Motor Type	Mag-drive	Mag-drive	Mag-drive	Mag-drive	Mag-drive	Mag-drive
Wattage	24	33	58	92	153	250
Amperage	0.40	0.55	0.80	0.85	1.46	2.60
Power Cord Length	12'	12'	25'	25'	25'	25'
Discharge Hose Diameter	1/2", 3/4", 1", 1.25"	1/2", 3/4", 1", 1.25"	1/2", 3/4", 1", 1.25"	3/4", 1", 1.25"	3/4", 1", 1.25"	3/4", 1", 1.25"
Dimensions	5.5"L x 4"W x 3.5"H	6"L x 4"W x 4"H	6"L x 4"W x 4"H	9"L x 5"W x 6"H	9.5"L x 6"W x 7"H	9.5"L x 6"W x 7"H
Warranty	3-Year Limited	3-Year Limited	3-Year Limited	3-Year Limited	3-Year Limited	3-Year Limited

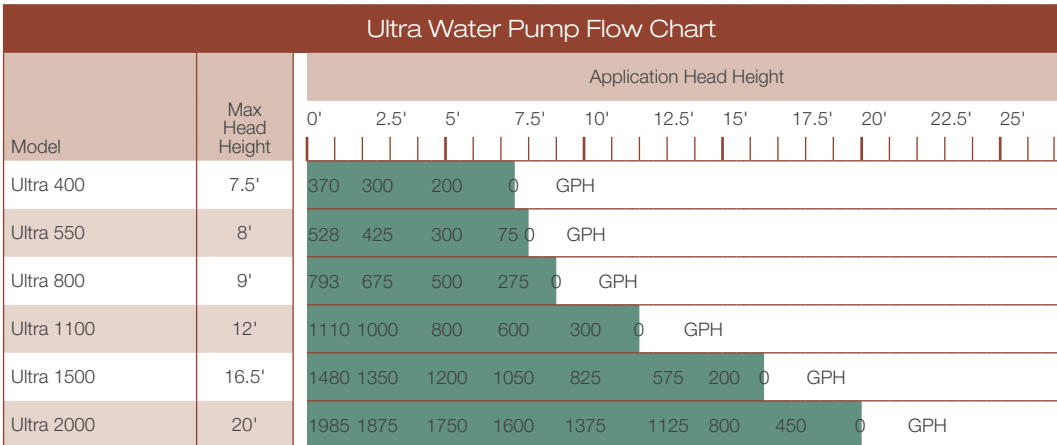

BEST Operating Zone

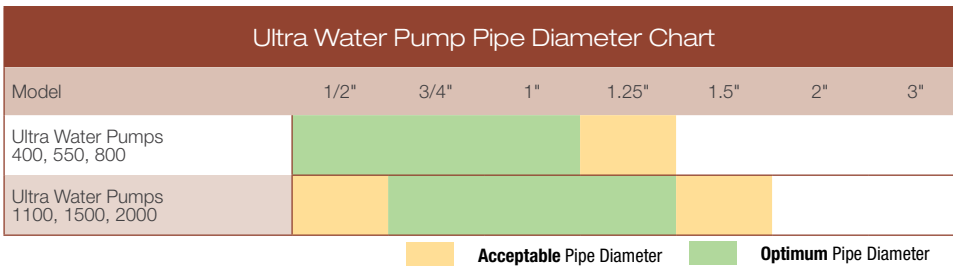

Acceptable Pipe Diameter **Optimum Pipe Diameter**

Ultra Water Pump Fountain Head Kits



Small Ultra Pump Fountain Head Kit

Ideal for Ultra 400, 550, and 800

#91045

Packaged Weight: 0.7 lb

Packaged Dimensions: 5.5"L x 3.5"W x 7.25"H



Large Ultra Pump Fountain Head Kit

Ideal for Ultra 1100, 1500, and 2000

#91046

Packaged Weight: 0.7 lb

Packaged Dimensions: 6"L x 3"W x 9"H

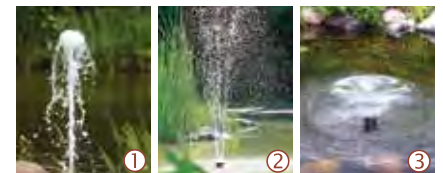

Included Fountain Heads

- ① Foaming Jet Fountain
- ② Daisy Fountain
- ③ Waterbell Fountain

Statuary Water Pumps

These high quality, magnetically-driven water pumps are ideal for supplying water to run fountains, container water features, and decorative spitters. The combination of energy-efficiency, mag-drive performance, water flow, and ease of maintenance makes this pump the ideal choice for discerning water feature owners.

- Extremely energy-efficient
- Mag-drive motor is simple and easy to maintain
- Durable pre-filter cage design prevents clogging and reduces pump maintenance
- Oil-free design prevents contamination



70 GPH Water Pump
#91023

Packaged Weight: 0.75 lb
Packaged Dimensions: 4.25"L x 4"W x 2.75"H



90 GPH Water Pump
#91024

Packaged Weight: 0.75 lb
Packaged Dimensions: 4.25"L x 4"W x 3.25"H



180 GPH Water Pump
#91025

Packaged Weight: 1.5 lb
Packaged Dimensions: 4"L x 4"W x 4.75"H



320 GPH Water Pump
#91026

Packaged Weight: 1.25 lb
Packaged Dimensions: 4"L x 4"W x 4.75"H



Features of the Statuary Pumps

- ① Mag-drive motor technology makes this pump energy-efficient and simple to maintain
- ② Included flow control allows you to create a customized water flow
- ③ The wide, flat base of the pump makes it stable and easy to place in the pond or fountain
- ④ Protective pump input strainer cover prevents debris from clogging or damaging pump, reducing maintenance
- ⑤ Intake strainer on the bottom of the pump prevents the pump from running dry or pulling in air in shallow applications

Statuary Water Pump Specifications

Model	70 GPH	90 GPH	180 GPH	320 GPH
Maximum Flow Rate (GPH)	70	90	180	320
Maximum Head Height	2'	3'	4'	5.5'
Motor Type	Mag-drive	Mag-drive	Mag-drive	Mag-drive
Wattage	3.0	4.3	9.3	17.6
Amperage	0.037	0.061	0.175	0.339
Power Cord Length	6'	6'	6'	6'
Discharge Hose Diameter	0.5", 0.625"	0.5", 0.625"	0.5", 0.625"	0.5", 0.625"
Dimensions	2"L x 1.5"W x 1.25"H	2.5"L x 1.75"W x 2"H	3"L x 2.5"W x 2"H	4"L x 3.25"W x 2.5"H
Warranty	3-Year Limited	3-Year Limited	3-Year Limited	3-Year Limited

Pond Powerhead

The Aquascape Pond Powerhead is an innovative new low voltage circulation pump designed to create water movement in ponds and water gardens. Either set the powerhead directly in the pond or disguise it using rocks or other materials.

- Great for solving problems with stagnant water
- Provides water movement, surface agitation, aeration, and circulation
- Small compact design makes it easy to install in a new or existing water feature
- No pipe or plumbing required
- Energy-efficient, low voltage 40-Watt motor can be powered by a standard outdoor 12-volt low voltage transformer. Transformers sold separately (see page 59)
- Includes 25 feet quick-connect cable
- Can be used alone or with additional Pond Powerheads to maximize circulation in larger water features

NEW



Pond Powerhead

#91142

Packaged Weight: 7.75 lb

Dimensions: 9.75"L x 5.75"W x 5.75"H



Features of the Pond Powerhead

- ① Adjustable head allows for directional flow control
- ② Propeller provides maximum water flow
- ③ Energy-efficient, 12-volt motor design
- ④ Durable construction ensures years of trouble-free use

Directional Flow Control



Compatible with Aquascape Garden and Pond Quick-Connect Splitters and Extension Cables (see page 56)

Pond Powerhead Application

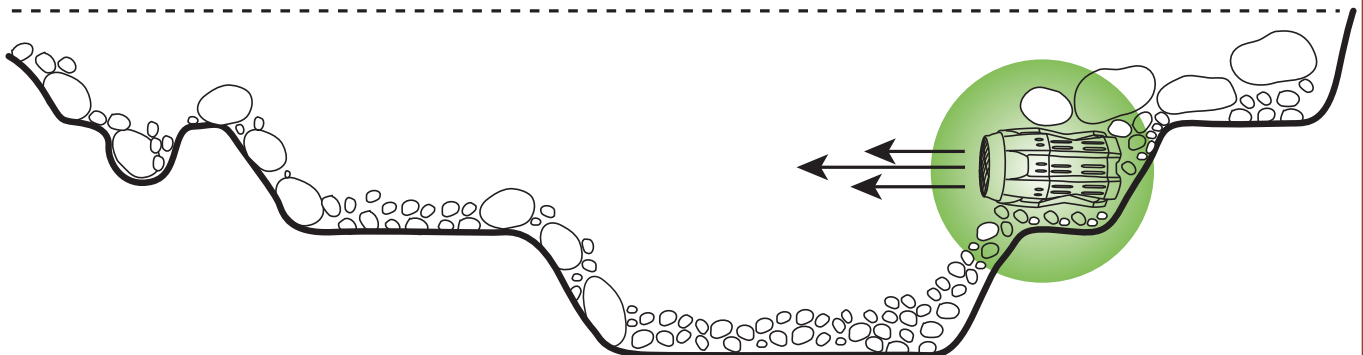



AERATION

Every biological process that occurs in ponds is dependent on oxygen. This is especially important in warmer temperatures or at night when plants are not converting sunlight into oxygen. Pond aerators supply dissolved oxygen directly to ponds and other water features, helping all biological processes and resulting in healthier fish and plants. Proper aeration creates a stable pond environment, keeping water healthy, clean, and clear. Aeration can also be used during cold winter months to keep a hole open in the ice formed at the surface of the pond, allowing for necessary de-gassing.

Aquascape provides a complete line of pond aeration supplies, making it easy to enhance your pond or water feature with effective aeration. Our aeration products are available as complete kits or individual components, including compressors, diffusers, weighted tubing, and more. The specification chart and following information will help you to make the right product selection. If you have any questions about pond aeration, please visit our website or contact Aquascape Customer Care.

2-Outlet and 4-Outlet Pond Aeration Kits

Aquascape 2-Outlet and 4-Outlet Pond Aeration Kits provide efficient aeration for ponds and water features up to 3,500 gallons, resulting in a healthier ecosystem and happier fish and plants.

- Extremely energy-efficient
- Quiet operation
- Simple to use and maintain
- Durable outer housing prevents damage
- Includes winter resistant air line, preassembled check valves, and air discs



2-Outlet Pond Aeration Kit
#75000

Packaged Weight: 5.5 lb



4-Outlet Pond Aeration Kit
#75001

Packaged Weight: 8.8 lb



Pond Aerator Aeration Disc
#75005

Packaged Weight: 9.7 lb



Features of the 2-Outlet and 4-Outlet Pond Aeration Kits

- ① Strong outer housing protects the pump from becoming damaged
- ② A thick rubber gasket reduces noise and prevents vibration
- ③ The wide, flat base of the pump makes it stable and easy to place
- ④ The integrated rubber feet minimize noise and vibration while maximizing stability

Pond Aerator Application

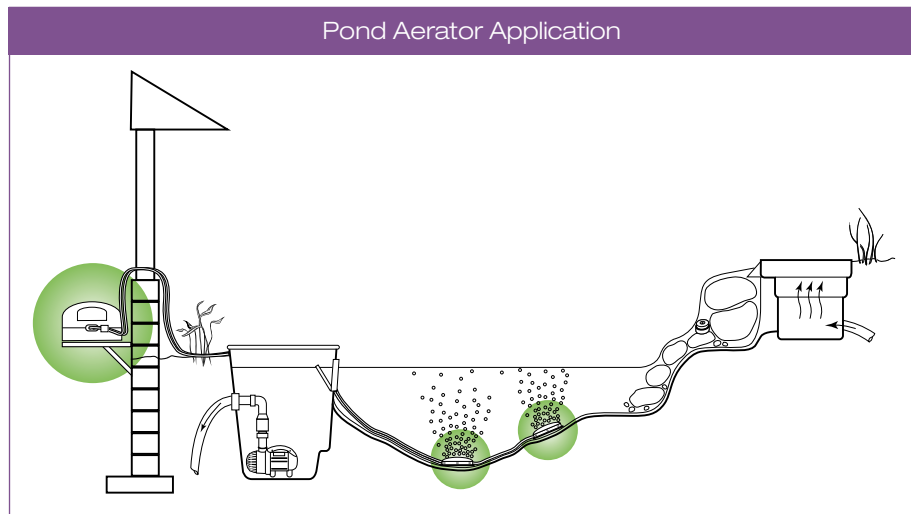

Pro Air Pond Aeration Kits



Pro Air 20 Pond Aeration Kit
#61009

Packaged Weight: 11.5 lb

The Aquascape Pro Air 20 Pond Aeration Kit provides effective oxygenation and water circulation in ponds up to 5,000 gallons.

- Comes complete with outdoor-rated, energy-efficient 15-Watt compressor
- Includes 10" clog-resistant Rubber Membrane Aeration Diffuser and 30' roll of braided tubing



Pro Air 60 Pond Aeration Kit
#61008

Packaged Weight: 24 lb

The Aquascape Pro Air 60 Pond Aeration Kit provides effective oxygenation and water circulation in ponds up to 15,000 gallons.

- Comes complete with outdoor-rated, energy-efficient 45-Watt compressor
- Includes 2-Way Aeration Compressor Manifold, (2) 10" clog-resistant Rubber Membrane Aeration Diffusers, and (2) 30' rolls of braided tubing

Pond Aerator Pump Specs

Model	2-Outlet Pond Aerator	4-Outlet Pond Aerator	PRO Air 20	PRO Air 60
Maximum Air Flow Rate (Loaded)	0.28 CFM (8 L/min)	0.49 CFM (14 L/min)	0.71 CFM (20 L/min)	2.1 CFM (60 L/min)
Maximum Air Depth (Loaded)	3.70 psi (0.26 kgf/cm ²)	3.98 psi (0.28 kgf/cm ²)	2.90 psi (0.20 kgf/cm ²)	5.08 psi (0.36 kgf/cm ²)
Number of Outlets	2	4	1	2
Wattage	6	11	15	45
Power Cord Length	6'	6'	6'	6'
Pump Dimensions	5.25"L x 4.75"W x 3.5"H	7.75"L x 7.25"W x 6.25"H	6"L x 5.5"W x 4.25"H	7.75"L x 7.25"W x 4"H
Aeration Diffuser	2 x 4" disc	4 x 4" disc	10" Rubber Membrane Aeration Diffuser	(2) 10" Rubber Membrane Aeration Diffusers
Length of Airline	(2) 25 ft. Rolls 3/16" Silicone	(4) 25 ft. Rolls 3/16" Silicone	1 x 30' Roll 3/8" Braided Vinyl	2 x 30' Rolls 3/8" Braided Vinyl
Check Valve	Included and Pre-installed	Included and Pre-installed	Included and Pre-installed	Included and Pre-installed
Warranty	3-Year Limited	3-Year Limited	3-Year Limited	3-Year Limited
Pond Size	Up to 2,000 gal	Up to 3,500 gal	Up to 5,000 gal	Up to 15,000 gal
Max Recommended Pond Depth	8.5'	9'	6.5'	11.5'

Pro Air Pond Aeration Accessories



Pro Air 20 Aeration Compressor
#61017

Packaged Weight: 5.5 lb

- Maximum Air Flow Rate (Loaded): 0.71 CFM (20 L/min)
- Wattage: 15



Pro Air 60 Aeration Compressor
#61016

Packaged Weight: 13.25 lb

- Maximum Air Flow Rate (Loaded): 2.1 CFM (60 L/min)
- Wattage: 45



Weighted Aeration Tubing
3/8" x 25'
#61011

Packaged Weight: 5.5 lb

- Self-sinking air supply tubing stays at the bottom of the pond
- Thick-walled and puncture resistant



Weighted Aeration Tubing
3/8" x 100'
#61014

Packaged Weight: 23 lb

- Self-sinking air supply tubing stays at the bottom of the pond
- Thick-walled and puncture resistant



10" Rubber Membrane
Aeration Diffuser
#61010

Packaged Weight: 3.5 lb



2-Way Aeration
Compressor Manifold
#61012

Packaged Weight: 0.25 lb

NOTE: Allows 2 tubing lines to be connected to the Pro Air 60 Aeration Compressor



Barbed Coupling 3/8"
#99159

Packaged Weight: 0.1 lb



LIGHTING

Aquascape LED Lighting

Add a new dimension to your water feature by bringing it to life at night. With today's busy lifestyle, it's important to be able to enjoy your pond or landscape at any time of the day. The complete line of Aquascape lighting makes enjoying your garden easy — day or night.

Aquascape LED lighting combines style and simplicity. Our component fixtures include a die-cast metal housing finished with a protective coating, providing a durable finish that will hold up in all weather conditions. Aquascape LED lighting can be used fully submersed or in traditional landscapes. Aquascape LED lights feature permanently sealed watertight fixtures and are backed by a limited full replacement warranty.

Garden and Pond LED Lights

- 40,000 hour bulb life
- Natural warm color light output 3000K
- Integrates easily with other 12-volt quick-connect components



Garden and Pond LED Spotlight Kit

#84030

Packaged Weight: 4 lb

Kit Includes:

- Three pre-wired 1-Watt LED lights
- 6-Watt 12V Quick-Connect Transformer
- Automatic on/off photocell with digital timer

**NEW
Design**



Garden and Pond 1-Watt
LED Waterfall and Up Light

#84032

Packaged Weight: 1.1 lb
Dimensions: 2" diameter x 1.5"H

- Light output equivalent to a 10-Watt halogen light
- 45 Lumens
- Integrated Cree LEDs



Garden and Pond 1-Watt
LED Spotlight

#84031

Packaged Weight: 0.9 lb
Dimensions: 1.25" diameter x 2"H

- Light output equivalent to a 10-Watt halogen light
- 45 Lumens
- Integrated Cree LEDs



Garden and Pond 3-Watt LED Spotlight

#84033

Packaged Weight: 1.75 lb
Dimensions: 3" diameter x 3"H

- Light output equivalent to a 20-Watt halogen light
- 150 Lumens
- Integrated Cree LEDs



Garden and Pond 6-Watt LED Spotlight

#84034

Packaged Weight: 2 lb
Dimensions: 3" diameter x 3"H

- Light output equivalent to a 50-Watt halogen light
- 340 Lumens
- Integrated Cree LEDs

LED Fountain Lights

- Integrated fitting for quick and easy installation in the top of decorative fountains
- 40,000 hour bulb life
- Powerful 2.5-Watt light
- Natural warm color light output 3000K
- Integrates easily with other 12-volt quick-connect components

NEW
Design



5
YEAR WARRANTY
GARANTIE DE 5 ANS



LED Fountain Light

#84008

Packaged Weight: 0.6 lb
Dimensions: 1.5"L x 1.5"W x 2.5"H

NEW
Design



5
YEAR WARRANTY
GARANTIE DE 5 ANS



LED Fountain Light with Transformer

#84009

Packaged Weight: 1.9 lb
Dimensions: 1.5"L x 1.5"W x 2.5"H

Path and Area LED Landscape Lights

Aquascape Path and Area LED Landscape Lights make it easy to illuminate any landscape, including areas surrounding waterfalls, ponds, and fountains. These energy-efficient LED lights provide beauty, safety, and visibility in any residential or commercial space. Two styles are available.

- Durable brass construction
- 3-Watt LED bulb included
- Heavy-duty stake included
- Integrates easily with other 12-volt quick-connect components



5
YEAR WARRANTY
GARANTIE DE 5 ANS



Path and Area 3-Watt LED Hat Top
Landscape Light

#84063

Packaged Weight: 1.75 lb
Dimensions: 6.5"L x 6.5"W x 18.25"H



5
YEAR WARRANTY
GARANTIE DE 5 ANS



Path and Area 3-Watt LED Dome Top
Landscape Light

#84064

Packaged Weight: 2 lb
Dimensions: 6.5"L x 6.5"W x 18.25"H

LED Lighting 6-Packs

Designed for quick and easy installation of Aquascape lighting components, Aquascape 6-Packs save you money, take up less space, reduce the amount of packaging, and are ideal for installations requiring multiple lights.



Garden and Pond 1-Watt LED Waterfall and Up Light 6-Pack

#84046

Packaged Weight: 7 lb
Packaged Dimensions: 14"L x 12"W x 7"H



Garden and Pond 1-Watt LED Spotlight 6-Pack

#84045

Packaged Weight: 7 lb
Packaged Dimensions: 13.5"L x 9.5"W x 6"H



Garden and Pond 3-Watt LED Spotlight 6-Pack

#84047

Packaged Weight: 13 lb
Packaged Dimensions: 17.5"L x 15.5"W x 7"H



Garden and Pond 6-Watt LED Spotlight 6-Pack

#84048

Packaged Weight: 13 lb
Packaged Dimensions: 17.5"L x 15.5"W x 7"H



Path and Area 3-Watt LED Hat Top Landscape Light 6-Pack

#84065

Packaged Weight: 9.5 lb
Packaged Dimensions: 13.75"L x 8"W x 10"H



Path and Area 3-Watt LED Dome Top Landscape Light 6-Pack

#84066

Packaged Weight: 11.5 lb
Packaged Dimensions: 13.75"L x 8"W x 10"H

Garden and Pond Photocell with Digital Timer



Garden and Pond Photocell with Digital Timer

#84039

Packaged Weight: 0.75 lb

Dimensions: 2"L x 1.25"W x 3.25"H with a 36" cord

- Can be used to control Aquascape white and color-changing lights
- Auto on at dusk/off at dawn or 4, 6, 8 hour timer option
- Built-in memory setting in case of power loss
- Integrates easily with other 12-volt quick-connect components
- Up to 60-Watt capacity

Garden and Pond Quick-Connect Extension Cables

Lighting extension cables allow for simple extension of Aquascape white LED lighting. Ideal for use with our 12-volt Quick-Connect transformers and 3-way/6-way splitters. **Not compatible with Aquascape Color-Changing Lighting.**

- No need to cut wires
- Quick-connect system provides a weatherproof seal



Garden and Pond 25' Quick-Connect Lighting Extension Cable

#98998

Packaged Weight: 1 lb
25' cord length



Garden and Pond 25' 5-Outlet Quick-Connect Lighting Extension Cable

#84023

Packaged Weight: 1 lb
25' cord length

Garden and Pond Splitters

Provides a simple connection of 3 or 6 light fixtures to a single transformer. Multiple 3-way and 6-way splitters can be chained together to attach additional fixtures. **Not compatible with Aquascape Color-Changing Lighting.**



Garden and Pond 3-Way Quick-Connect Splitter

#98489

Packaged Weight: 0.5 lb
6" cord length



Garden and Pond 6-Way Quick-Connect Splitter

#84022

Packaged Weight: 0.75 lb
36" cord length

LED Color-Changing Lights

- Color-changing diodes provide an impressive range of color options
- White diode provides a true white when desired
- Integrates easily with Aquascape color-changing lighting accessories
- Requires Color-Changing Lighting Control Hub and standard 12-volt transformer

NEW



2-Watt LED Color-Changing
Waterfall and Up Light

#84057

Packaged Weight: 1.1 lb
Dimensions: 2"L x 2"W x 1.5"H

NEW



4.5-Watt LED Color-Changing
Spotlight

#84059

Packaged Weight: 1.75 lb
Dimensions: 3"L x 3"W x 3"H

NEW



8-Watt LED Color-Changing Spotlight

#84060

Packaged Weight: 2 lb
Dimensions: 3"L x 3"W x 3"H

LED Color-Changing Fountain Lights

- Color-changing and white diodes provide an impressive range of color options
- Integrates easily with Aquascape color-changing lighting accessories
- Integrated fitting for quick and easy installation in the top of decorative fountains

NEW

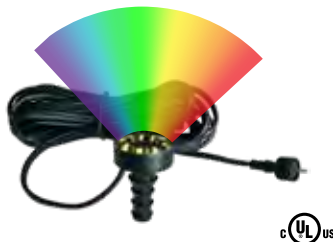

LED Color-Changing Fountain Light

#84072

Packaged Weight: 0.6 lb
Dimensions: 1.5"L x 1.5"W x 2.5"H

- Requires Color-Changing Lighting Control Hub and standard 12-volt transformer

NEW



LED Color-Changing Fountain Light Kit

#84055

Packaged Weight: 1.9 lb
Dimensions: 1.5"L x 1.5"W x 2.5"H

- Includes remote control and transformer

Color-Changing Lighting Control Hub

- Turn lights on and off or select between lighting color design options
- Remote control included
- 150-Watt lighting capacity
- Requires standard 12-volt transformer (see page 59)



Color-Changing Lighting Control Hub

#84061

Packaged Weight: 1.5 lb
Dimensions: 4"L x 4"W x 1.5"H

Color-Changing Lighting Extension Cables

- Allow for simple extension of Aquascape Color-Changing Lighting
- No need to cut wires
- Quick-connect fittings provide weather-proof connections



25' Color-Changing Lighting Extension Cable

#84069

Packaged Weight: 1 lb
25' cord length



25' 5-Outlet Color-Changing Lighting Extension Cable

#84070

Packaged Weight: 1 lb
25' cord length

Color-Changing Lighting Splitters

- Provide a simple way to connect multiple color-changing lights to one power source
- Choice of 3-Way or 6-Way
- Color-changing quick-connect fittings provide weather-proof connections



3-Way Color-Changing Splitter

#84062

Packaged Weight: 0.5 lb
6" cord length



6-Way Color-Changing Splitter

#84068

Packaged Weight: 0.75 lb
36" cord length

Garden and Pond 12V Quick-Connect Transformers

Simple plug-in transformers provide an economical solution for operating low voltage lighting fixtures, including Aquascape white and color-changing lighting. Each transformer includes a single quick-connect cable port for adding a light. Multiple light fixtures can be added by using the 3-Way or 6-Way Quick-Connect Splitter.



Garden and Pond
60-Watt 12V Quick-Connect
Transformer

#98486

Packaged Weight: 3.5 lb
Dimensions: 3"L x 6"W x 3"H



Garden and Pond
20-Watt 12V Quick-Connect
Transformer

#98485

Packaged Weight: 1.75 lb
Dimensions: 4"L x 1.75"W x 2.5"H



Garden and Pond
6-Watt 12V Quick-Connect
Transformer

#98375

Packaged Weight: 1 lb
Dimensions: 3"L x 1.5"W x 2.25"H



Garden and Pond
150-Watt Transformer with Photocell

#01002

Packaged Weight: 8 lb
Dimensions: 4"L x 7"W x 3.5"H

- Includes 4, 6, 8 hour photocell intervals options, as well as manual on/off override.



Garden and Pond
60-Watt Transformer with Photocell

#99070

Packaged Weight: 4 lb
Dimensions: 3.5"L x 7"W x 2.5"H

- Includes 4, 6, 8 hour photocell intervals options.

Lighting Charts

Garden and Pond LED Lighting Chart

Model	Fountain Light	1-Watt Waterfall and Up Light	1-Watt Spotlight	3-Watt Spotlight	6-Watt Spotlight
Dimensions	1.5" diameter x 2.5"H	2" diameter x 1.25"H	1.5" diameter x 2"H	3" diameter x 3"H	3" diameter x 3"H
Material	Plastic	Die-Cast Metal	Die-Cast Metal	Die-Cast Metal	Die-Cast Metal
Voltage Min-Max	10.8V – 15V	9V – 15V	9V – 15V	9V – 15V	9V – 15V
Wattage	2.5W	1.2W±10%	1.2W±10%	3W±10%	5.8W±10%
Lumens	24 lm	45 lm	45 lm	150 lm	340 lm
Temperature in Kevlin	3,000 K / White	3,000 K	3,000 K	3,000 K	3,000 K
Color Rendering Index (CRI)	70	75	75	75	75
Beam Angle Spread	30°	30°	30°	30°	30°
Cord Length	15'	14.5'	14.5'	14.5'	14.5'

Path and Area LED Landscape Lighting Chart

Model	3-Watt Hat-Top	3-Watt Dome-Top
Dimensions	6.5" diameter x 18.25"H	6.5" diameter x 18.25"H
Material	Brass	Brass
Voltage Min-Max	9V – 15V	9V – 15V
Wattage	3W±10%	3W±10%
Lumens	270 lm	270 lm
Temperature in Kevlin	2,700 K	2,700 K
Color Rendering Index (CRI)	80	80
Beam Angle Spread	120°	90°
Beam Spread Diameter	6.5' / 2 m	6' / 1.8 m
Cord Length	3' / 0.91 m	3' / 0.91 m

Color-Changing LED Lighting Chart

Model	Fountain Light	2-Watt Waterfall and Up Light	4.5-Watt Spotlight	8-Watt Spotlight
Dimensions	1.5" diameter x 2.5"H	2" diameter x 1.25"H	3" diameter x 3"H	3" diameter x 3"H
Material	Plastic	Die-Cast Metal	Die-Cast Metal	Die-Cast Metal
Voltage Min-Max	10.8V – 15V	10.8V – 15V	10.8V – 15V	10.8V – 15V
Wattage	2.5W±10%	2W±10%	4.5W±10%	8W±10%
Lumens	20 lm / White	52 lm / White	128 lm / White	223 lm / White
Temperature in Kevlin	3,000 K / White	3,000 K / White	3,000 K / White	3,000 K / White
Color Rendering Index (CRI)	70 / White	70 / White	70 / White	70 / White
Beam Angle Spread	30°	30°	30°	30°
Cord Length	15'	15'	15'	15'



**NEW
Redesigned
Packaging**

WATER TREATMENTS

Aquascape Water Treatments

Combining science with simplicity, Aquascape makes it easy to maintain a healthy, well-balanced water feature. Aquascape Water Treatments make dosing simple and affordable. Put away your calculator and enjoy a clean, clear, and healthy ecosystem pond, Pondless® Waterfall, or decorative fountain with the complete line of Aquascape water treatment products

<p>Beneficial Bacteria</p> <ul style="list-style-type: none"> Beneficial Bacteria Beneficial Bacteria Concentrate Cold Water Beneficial Bacteria Pond Starter Bacteria Bacteria Bubble Tabs 	<p>Problem Solving</p> <ul style="list-style-type: none"> NEW QuickFix Pond Gummy Black Pond Dye Blue Pond Dye Concentrated Barley Straw Pellets SAB Stream & Pond Cleaner Barley Straw Extract Rapid Clear Flocculant Pond & Debris Clarifier 	<p>Water Conditioners</p> <ul style="list-style-type: none"> Pond Detoxifier Ammonia Neutralizer Alkalinity Booster Pond Foam Free Activated Pond Carbon
<p>Sludge Fighting</p> <ul style="list-style-type: none"> NEW Pond Sludge Remover Packs Sludge & Filter Cleaner Sludge Cleaner Bubble Tabs 	<p>Fountain Treatments</p> <ul style="list-style-type: none"> Patio Pond Maintenance Tabs Fountain Foam Free Rock & Fountain Cleaner Fountain Maintenance Fountain Scale Free 	<p>Fish Treatments</p> <ul style="list-style-type: none"> Pond Salt

Automatic Dosing System

In order for water treatments to work correctly and to maintain optimum water quality, they should be added consistently and on a regular basis. The Aquascape Automatic Dosing System accurately and consistently applies your choice of specially-formulated water treatments, eliminating the guesswork and routine of manually adding water treatments to your water feature.

- Helps maintain optimum water quality
- Easy to use and fully programmable
- Can be used on almost any pond, fountain, or water feature
- Dependable and quiet operation

Each type of water feature has its own set of requirements to maintain optimal water quality. In order to provide optimum results, we have created two categories of treatment listed below.



Automatic Dosing System
for Ponds
#96030

Packaged Weight: 4 lb

- Free Maintain for Ponds water treatment included
- Ideal for use with ponds and water gardens



Automatic Dosing System
for Fountains
#96031

Packaged Weight: 4 lb

- Free Prevent for Fountains water treatment included
- Ideal for use with fountains and Pondless® Waterfalls

Replacement Frequency	
Water Feature Size	Approximate Days of Treatment
Up to 500 gal / 1 893 L	166
1,000 gal / 3 785 L	83
1,500 gal / 5 678 L	55
2,000 gal / 7 571 L	42
2,500 gal / 9 464 L	33
3,000 gal / 11 356 L	28
3,500 gal / 13 249 L	24
4,000 gal / 15 142 L	21
4,500 gal / 17 034 L	18
5,000 gal / 18 927 L	16

Automatic Dosing System Water Treatments



1 Maintain for Ponds Automatic Dosing System

#96032

Packaged Weight: 2.7 lb

- Combines effective pond treatments in one powerful formulation
- Keeps ponds clean, clear, and healthy
- Contains a beneficial bacteria blend, phosphate binder, flocculant clarifier, and pond detoxifier



2 Clean for Ponds Automatic Dosing System

#96034

Packaged Weight: 2.7 lb

- Naturally reduces organic sludge caused by fish food, fish waste, and leaves or debris
- Cleans rocks and gravel
- Reduces filter maintenance



3 Clear for Ponds Automatic Dosing System

#96033

Packaged Weight: 2.7 lb

- Concentrated formulation of clarifiers eliminate unsightly water conditions
- Clears cloudy/discolored water
- Controls debris that attaches to rocks and gravel



4 Protect for Ponds Automatic Dosing System

#96035

Packaged Weight: 2.7 lb

- All-natural formulation effectively protects pond fish
- Reduces fish stress, prevents parasites and infections, and accelerates healing
- Use after handling fish or performing cleanouts and water changes



1 Prevent for Fountains Automatic Dosing System

#96042

Packaged Weight: 2.7 lb

- Controls white-scale buildup, foam, stains, and unsightly water conditions, including debris buildup in the water and on the surface of fountains, rocks, or gravel
- Not for use with fish or plants



2 Clean for Fountains Automatic Dosing System

#96037

Packaged Weight: 2.7 lb

- Cleans and clarifies fountains with standing water, plants, or fish
- Contains a flocculant clarifier and phosphate binder to clear and prevent suspended debris

Water Treatments



1 Maintain for Ponds

- Combines effective pond treatments in one powerful formulation
- Keeps ponds clean, clear, and healthy
- Contains a beneficial bacteria blend, phosphate binder, flocculant clarifier, and pond detoxifier



2 Clean for Ponds

- Naturally reduces organic sludge caused by fish food, fish waste, and leaves or debris
- Cleans rocks and gravel
- Reduces filter maintenance



3 Clear for Ponds

- Concentrated formulation of clarifiers eliminate unsightly water conditions
- Clears cloudy/discolored water
- Controls debris that attaches to rocks and gravel

Maintain for Ponds

8 oz / 236 ml

#96057

Packaged Weight: 0.6 lb

1 pump treats 100 gal / 378 L

1 bottle treats 5,000 gal / 18,900 L

Clean for Ponds

8 oz / 236 ml

#96061

Packaged Weight: 0.6 lb

1 pump treats 100 gal / 378 L

1 bottle treats 5,000 gal / 18,900 L

Clear for Ponds

8 oz / 236 ml

#96065

Packaged Weight: 0.6 lb

1 pump treats 100 gal / 378 L

1 bottle treats 5,000 gal / 18,900 L

Maintain for Ponds

16 oz / 473 ml

#96058

Packaged Weight: 1.2 lb

1 pump treats 100 gal / 378 L

1 bottle treats 10,000 gal / 37,800 L

Clean for Ponds

16 oz / 473 ml

#96062

Packaged Weight: 1.2 lb

1 pump treats 100 gal / 378 L

1 bottle treats 10,000 gal / 37,800 L

Clear for Ponds

16 oz / 473 ml

#96066

Packaged Weight: 1.2 lb

1 pump treats 100 gal / 378 L

1 bottle treats 10,000 gal / 37,800 L

Maintain for Ponds

32 oz / 946 ml

#96059

Packaged Weight: 2.3 lb

1 pump treats 100 gal / 378 L

1 bottle treats 20,000 gal / 75,600 L

Clean for Ponds

32 oz / 946 ml

#96063

Packaged Weight: 2.3 lb

1 pump treats 100 gal / 378 L

1 bottle treats 20,000 gal / 75,600 L

Clear for Ponds

32 oz / 946 ml

#96067

Packaged Weight: 2.3 lb

1 pump treats 100 gal / 378 L

1 bottle treats 20,000 gal / 75,600 L

Maintain for Ponds

1 gal / 3.78 L

#96060

Packaged Weight: 9.2 lb

1 pump treats 600 gal / 2,268 L

1 bottle treats 80,000 gal / 302,400 L

Clean for Ponds

1 gal / 3.78 L

#96064

Packaged Weight: 9.2 lb

1 pump treats 600 gal / 2,268 L

1 bottle treats 80,000 gal / 302,400 L

Clear for Ponds

1 gal / 3.78 L

#96068

Packaged Weight: 9.2 lb

1 pump treats 600 gal / 2,268 L

1 bottle treats 80,000 gal / 302,400 L

Water Treatments



④ Protect for Ponds

- All-natural formulation effectively protects pond fish
- Reduces fish stress, prevents parasites and infections, and accelerates healing
- Use after handling fish or performing cleanouts and water changes



① Prevent for Fountains

- Controls white-scale buildup, foam, stains, and unsightly water conditions, including debris buildup in the water and on the surface of fountains, rocks, or gravel
- Not for use with fish or plants



② Clean for Fountains

- Cleans and clarifies fountains with standing water, plants, or fish
- Contains a flocculant clarifier and phosphate binder to clear and prevent suspended debris

Protect for Ponds
8 oz / 236 ml
#96069

Packaged Weight: 0.6 lb
1 pump treats 100 gal / 378 L
1 bottle treats 5,000 gal / 18,900 L

Prevent for Fountains
8 oz / 236 ml
#96073

Packaged Weight: 0.6 lb
1 pump treats 100 gal / 378 L
1 bottle treats 5,000 gal / 18,900 L

Clean for Fountains
8 oz / 236 ml
#96077

Packaged Weight: 0.6 lb
1 pump treats 100 gal / 378 L
1 bottle treats 5,000 gal / 18,900 L

Protect for Ponds
16 oz / 473 ml
#96070

Packaged Weight: 1.2 lb
1 pump treats 100 gal / 378 L
1 bottle treats 10,000 gal / 37,800 L

Prevent for Fountains
16 oz / 473 ml
#96074

Packaged Weight: 1.2 lb
1 pump treats 100 gal / 378 L
1 bottle treats 10,000 gal / 37,800 L

Clean for Fountains
16 oz / 473 ml
#96078

Packaged Weight: 1.2 lb
1 pump treats 100 gal / 378 L
1 bottle treats 10,000 gal / 37,800 L

Protect for Ponds
32 oz / 946 ml
#96071

Packaged Weight: 2.3 lb
1 pump treats 100 gal / 378 L
1 bottle treats 20,000 gal / 75,600 L

Prevent for Fountains
32 oz / 946 ml
#96075

Packaged Weight: 2.3 lb
1 pump treats 100 gal / 378 L
1 bottle treats 20,000 gal / 75,600 L

Clean for Fountains
32 oz / 946 ml
#96079

Packaged Weight: 2.3 lb
1 pump treats 100 gal / 378 L
1 bottle treats 20,000 gal / 75,600 L

Protect for Ponds
1 gal / 3.78 L
#96072

Packaged Weight: 9.2 lb
1 pump treats 600 gal / 2,268 L
1 bottle treats 80,000 gal / 302,400 L

Prevent for Fountains
1 gal / 3.78 L
#96076

Packaged Weight: 9.2 lb
1 pump treats 600 gal / 2,268 L
1 bottle treats 80,000 gal / 302,400 L

Clean for Fountains
1 gal / 3.78 L
#96080

Packaged Weight: 9.2 lb
1 pump treats 600 gal / 2,268 L
1 bottle treats 80,000 gal / 302,400 L

Automatic Dosing Treatment Reference Chart for Ponds

MAINTAIN

1

Maintain for Ponds reduces maintenance and helps maintain optimum water quality by combining our most effective treatments into one powerful treatment. The formulation includes a beneficial bacteria blend, phosphate binder, flocculant, and dextoxifier, resulting in a healthy, crystal-clear, maintenance-free pond.

CLEAN

2

Clean for Ponds uses a powerful blend of heterotrophic bacteria to digest organic waste or sludge caused by uneaten fish food, fish waste, and leaves or debris, naturally cleaning the rocks and gravel. Reducing organic waste helps keep ponds and pond filters clean while optimizing water clarity and quality.

CLEAR

3

Clear for Ponds uses a concentrated formulation of clarifiers to effectively resolve existing water quality problems, including cloudy or discolored water and issues with debris attached to rocks and gravel. The formulation also contains a phosphate binder which works to prevent issues with water clarity and debris buildup.

PROTECT

4

Protect for Ponds uses an all-natural formulation of tea tree oil and other plant-based biopolymers to effectively protect pond fish, reducing fish stress, preventing parasites and infections, and accelerating healing of superficial wounds, scrapes, and breeding abrasions. Protect is great for use after handling fish or performing cleanouts and water changes.

Automatic Dosing Treatment Reference Chart for Fountains

PREVENT

1

Prevent for Fountains keeps fountains and water features clean and clear, controlling white-scale buildup, foam, stains, and unsightly water conditions without damaging fountain surfaces. The formulation contains a special blend of clarifiers, designed to clear and prevent debris buildup in the water and on the surface of fountains, rocks, or gravel. Prevent for Fountains is not intended for use in water features containing fish or plants.

CLEAN

2

Clean for Fountains effectively cleans and clarifies fountains with standing water, plants, or fish, significantly reducing maintenance and issues with water quality. The formulation contains a flocculant and powerful phosphate binder to help clear and prevent unsightly suspended debris. Clean for Fountains is safe for use with fish and plants.

Beneficial Bacteria

Provides clean, clear, and healthy water conditions and reduces pond maintenance.

- Effectively supports the nitrogen cycle
- Safe for fish, plants, pets, and wildlife



Beneficial Bacteria

- Contains 8 strains of bacteria including photosynthetic
- Contains marigold and vitamin B



Beneficial Bacteria Concentrate

- Contains 8 strains of bacteria including photosynthetic
- Contains marigold and vitamin B
- Ideal for larger ponds



Cold Water Beneficial Bacteria

- Reduces ammonia, nitrite, and organic debris
- Ideal for use in water colder than 50°F (10°C)

Beneficial Bacteria
8 oz / 236 ml
#98886

Packaged Weight: 0.6 lb
1 pump treats 100 gal / 378 L
1 bottle treats 5,000 gal / 18,900 L

Beneficial Bacteria Concentrate
4.4 oz / 125 g
#98925

Packaged Weight: 0.3 lb
1 scoop treats 1,300 gal / 4,914 L
1 container treats 26,000 gal / 98,280 L

Cold Water Beneficial Bacteria
8 oz / 236 ml
#98892

Packaged Weight: 0.6 lb
1 pump treats 100 gal / 378 L
1 bottle treats 5,000 gal / 18,900 L

Beneficial Bacteria
16 oz / 473 ml
#98887

Packaged Weight: 1.2 lb
1 pump treats 100 gal / 378 L
1 bottle treats 10,000 gal / 37,800 L

Beneficial Bacteria Concentrate
8.8 oz / 250 g
#98948

Packaged Weight: 0.6 lb
1 scoop treats 1,300 gal / 4,914 L
1 container treats 52,000 gal / 196,560 L

Cold Water Beneficial Bacteria
16 oz / 473 ml
#98893

Packaged Weight: 1.2 lb
1 pump treats 100 gal / 378 L
1 bottle treats 10,000 gal / 37,800 L

Beneficial Bacteria
32 oz / 946 ml
#98888

Packaged Weight: 2.3 lb
1 pump treats 100 gal / 378 L
1 bottle treats 20,000 gal / 75,600 L

Beneficial Bacteria Concentrate
1.1 lb / 500 g
#98949

Packaged Weight: 1.2 lb
1 scoop treats 1,300 gal / 4,914 L
1 container treats 104,000 gal / 393,120 L

Cold Water Beneficial Bacteria
32 oz / 946 ml
#98894

Packaged Weight: 2.3 lb
1 pump treats 100 gal / 378 L
1 bottle treats 20,000 gal / 75,600 L

Beneficial Bacteria
Refill Pouch 32 oz / 946 ml
#40002

Packaged Weight: 2.2 lb
1oz treats 600 gal / 2,268 L
1 bottle treats 20,000 gal / 75,600 L

Beneficial Bacteria Concentrate
7 lb / 3.2 kg
#98950

Packaged Weight: 7.8 lb
1 scoop treats 1,300 gal / 4,914 L
1 container treats 665,600 gal / 2,515,968 L

Cold Water Beneficial Bacteria
1 gal / 3.78 L
#96021

Packaged Weight: 9.2 lb
1 pump treats 600 gal / 2,268 L
1 bottle treats 80,000 gal / 302,400 L

Beneficial Bacteria
1 gal / 3.78 L
#98885

Packaged Weight: 9.2 lb
1 pump treats 600 gal / 2,268 L
1 bottle treats 80,000 gal / 302,400 L

Beneficial Bacteria (Continued)



Pond Starter Bacteria

- Quickly establishes biological ecosystem
- Great for spring start-ups and new ponds
- Safe for fish, plants, and animals



Bacteria Bubble Tabs

- Keeps pond water clean and clear
- Maintains a balanced ecosystem
- Reduces pond maintenance

<p style="text-align: center;">Pond Starter Bacteria 8 oz / 236 ml #96013</p> <p>Packaged Weight: 0.6 lb</p> <p>1 pump treats 100 gal / 378 L 1 bottle treats 5,000 gal / 18,900 L</p>	<p style="text-align: center;">Pond Starter Bacteria 32 oz / 946 ml #96015</p> <p>Packaged Weight: 2.3 lb</p> <p>1 pump treats 100 gal / 378 L 1 bottle treats 20,000 gal / 75,600 L</p>	<p style="text-align: center;">Bacteria Bubble Tabs 36 Tabs #98951</p> <p>Packaged Weight: 0.3 lb</p> <p>1 tablet treats 100 gal / 378 L 1 container treats 3,600 gal / 13,608 L</p>
<p style="text-align: center;">Pond Starter Bacteria 16 oz / 473 ml #96014</p> <p>Packaged Weight: 1.2 lb</p> <p>1 pump treats 100 gal / 378 L 1 bottle treats 10,000 gal / 37,800 L</p>	<p style="text-align: center;">Pond Starter Bacteria 1 gal / 3.78 L #96008</p> <p>Packaged Weight: 9.2 lb</p> <p>1 pump treats 600 gal / 2,268 L 1 bottle treats 80,000 gal / 302,400 L</p>	<p style="text-align: center;">Bacteria Bubble Tabs 72 Tabs #98930</p> <p>Packaged Weight: 0.6 lb</p> <p>1 tablet treats 100 gal / 378 L 1 container treats 7,200 gal / 27,216 L</p>

Problem Solving



Black Pond Dye 8 oz / 236 ml

#98884

Packaged Weight: 0.6 lb

1 pump treats 100 gal / 378 L
1 bottle treats 5,000 gal / 18,900 L

- Filters sunlight and cools water
- Contains humic acid and enzymes to help balance the pond ecosystem
- Creates a shimmering effect
- One dosage lasts up to 6 weeks



Blue Pond Tint 8 oz / 236 ml

#98882

Packaged Weight: 0.6 lb

1 pump treats 100 gal / 378 L
1 bottle treats 5,000 gal / 18,900 L

- Filters sunlight and cools water
- Added enzymes help balance the pond ecosystem
- One dosage lasts up to 6 weeks



Concentrated Barley Straw Pellets 5 lb / 2.3 kg

#96029

Packaged Weight: 5.7 lb

1 container treats 1,000 gal / 3,780 L

- Fast-acting, natural way to clarify pond water
- Comes in a resealable mesh bag
- Contains a blend of bacteria and enzymes



SAB Stream & Pond Cleaner

- Breaks down debris
- Maintains a balanced ecosystem
- Reduces pond maintenance
- Phosphate binder



Barley Straw Extract

- Promotes clean, clear water conditions in ponds and streams
- Starts working instantly
- Concentrated formulation with added enzymes



Rapid Clear Flocculant

- Quickly clears cloudy water by clumping debris
- Works within 24 hours
- For best results, use in combination with a Rapid Clear Fine Filter Pad (#80001)

SAB Stream & Pond Cleaner
4.4 oz / 125 g
#98898

Packaged Weight: 0.3 lb

1 scoop treats 120 gal / 454 L
1 container treats 1,200 gal / 4,536 L

Barley Straw Extract
8 oz / 236 ml
#98903

Packaged Weight: 0.6 lb

1 pump treats 100 gal / 378 L
1 bottle treats 5,000 gal / 18,900 L

Rapid Clear Flocculant
8 oz / 236 ml
#98879

Packaged Weight: 0.6 lb

1 pump treats 100 gal / 378 L
1 bottle treats 5,000 gal / 18,900 L

SAB Stream & Pond Cleaner
8.8 oz / 250 g
#98899

Packaged Weight: 0.6 lb

1 scoop treats 120 gal / 454 L
1 container treats 2,400 gal / 9,072 L

Barley Straw Extract
16 oz / 473 ml
#98904

Packaged Weight: 1.2 lb

1 pump treats 100 gal / 378 L
1 bottle treats 10,000 gal / 37,800 L

Rapid Clear Flocculant
16 oz / 473 ml
#96049

Packaged Weight: 1.2 lb

1 pump treats 100 gal / 378 L
1 bottle treats 10,000 gal / 37,800 L

SAB Stream & Pond Cleaner
1.1 lb / 500 g
#98900

Packaged Weight: 1.2 lb

1 scoop treats 120 gal / 454 L
1 container treats 4,920 gal / 18,597 L

Barley Straw Extract
32 oz / 946 ml
#98905

Packaged Weight: 2.3 lb

1 pump treats 100 gal / 378 L
1 bottle treats 20,000 gal / 75,600 L

Rapid Clear Flocculant
Refill Pouch 32 oz / 946 ml
#40006

Packaged Weight: 2.2 lb

1oz treats 600 gal / 2,268 L
1 bottle treats 20,000 gal / 75,600 L

SAB Stream & Pond Cleaner
7 lb / 3.2 kg
#98896

Packaged Weight: 7.8 lb

1 scoop treats 1,420 gal / 5,368 L
1 container treats 31,240 gal / 118,087 L

Barley Straw Extract
1 gal / 3.78 L
#96012

Packaged Weight: 9.2 lb

1 pump treats 600 gal / 2,268 L
1 bottle treats 80,000 gal / 302,400 L

Rapid Clear Flocculant
1 gal / 3.78 L
#96007

Packaged Weight: 9.2 lb

1 pump treats 600 gal / 2,268 L
1 bottle treats 80,000 gal / 302,400 L



Rapid Clear Fine Filter Pads

#80001

Packaged Weight: 0.6 lb
12"W x 24"L

- Speeds up filtering of flocculated particles
- For best results, use in combination with Rapid Clear Flocculant water treatments
- Enhances water quality
- Includes three pads

NEW



QuickFix Pond Gummy #96083

Packaged Weight: 0.3 lb

1 package treats 3,000 gal / 11,340 L

- Rapidly resolves pond problems, including cloudy water
- Innovative gummy makes for quick and easy application
- Targets ammonia, nitrite, and phosphate
- Helps control organic waste and debris



Pond and Debris Clarifier

- Quickly cleans unsightly debris
- Scientifically blended to quickly restore the water quality
- Quickly clears unsightly debris
- Reduces pond maintenance

Pond and Debris Clarifier

8 oz / 236 ml

#96002

Packaged Weight: 0.7 lb

1 pump treats 100 gal / 378 L

1 bottle treats 5,000 gal / 18,900 L

Pond and Debris Clarifier

16 oz / 473 ml

#96003

Packaged Weight: 1.2 lb

1 pump treats 100 gal / 378 L

1 bottle treats 10,000 gal / 37,800 L

Pond and Debris Clarifier

32 oz / 946 ml

#96005

Packaged Weight: 2.2 lb

1 pump treats 100 gal / 378 L

1 bottle treats 20,000 gal / 75,600 L

Pond and Debris Clarifier

Refill Pouch 32 oz / 946 ml

#96004

Packaged Weight: 9 lb

1 oz treats 600 gal / 2,268 L

1 pouch treats 20,000 gal / 75,600 L

Pond and Debris Clarifier

1 gal / 3.78 L

#96006

Packaged Weight: 9.2 lb

1 pump treats 600 gal / 2,268 L

1 bottle treats 80,000 gal / 302,400 L

Water Conditioners



Pond Foam Free

8 oz / 236 ml

#98909

Packaged Weight: 0.6 lb

1 pump treats 100 gal / 378 L

1 bottle treats 5,000 gal / 18,900 L

- Safely eliminates foam near waterfalls
- Helps maintain the beauty of your pond
- Helps keep water clean and clear of foam
- Safe for fish, animals, and plants



Activated Pond Carbon

2.2 lb / 1 kg

#80000

Packaged Weight: 2.2 lb

1 scoop treats 25 gal / 95 L

1 container treats up to 800 gal / 3,024 L

- Removes discoloration and odors
- Made with bamboo carbon
- Clarifies pond water
- Quickly reduces pond odor

Water Conditioners (Continued)



Pond Detoxifier

- Makes tap water safe for fish and plants
- Removes and detoxifies chlorine
- Neutralizes ammonia
- Detoxifies and chelates copper and heavy metal

Pond Detoxifier

8 oz / 236 ml

#98876

Packaged Weight: 0.6 lb

1 pump treats 100 gal / 378 L

1 bottle treats 5,000 gal / 18,900 L

Pond Detoxifier

16 oz / 473 ml

#98877

Packaged Weight: 1.2 lb

1 pump treats 100 gal / 378 L

1 bottle treats 10,000 gal / 37,800 L

Pond Detoxifier

Refill Pouch 32 oz / 946 ml

#40005

Packaged Weight: 2.2 lb

1oz treats 600 gal / 2,268 L

1 bottle treats 20,000 gal / 75,600 L

Pond Detoxifier

1 gal / 3.78 L

#96010

Packaged Weight: 9.2 lb

1 pump treats 600 gal / 2,268 L

1 bottle treats 80,000 gal / 302,400 L



Ammonia Neutralizer

- Neutralizes large concentrations of toxic ammonia
- Makes pond water safe for fish and plants
- Detoxifies chloramine in tap water

Ammonia Neutralizer

16 oz / 473 ml

#96050

Packaged Weight: 1.2 lb

1 pump treats 100 gal / 378 L

1 bottle treats 10,000 gal / 37,800 L

Ammonia Neutralizer

32 oz / 946 ml

#96051

Packaged Weight: 2.3 lb

1 pump treats 100 gal / 378 L

1 bottle treats 20,000 gal / 75,600 L

Ammonia Neutralizer

1 gal / 3.78 L

#96052

Packaged Weight: 9.2 lb

1 pump treats 600 gal / 2,268 L

1 bottle treats 80,000 gal / 302,400 L



Alkalinity Booster

- Increases overall KH/pH and alkalinity
- Lab tested and pharmaceutical grade
- Dissolves completely and easily in pond water
- Phosphate and ammonia free

Alkalinity Booster with Phosphate Binder

1.1 lb / 500 g

#96027

Packaged Weight: 3 lb

1 scoop treats 125 gal / 472 L

1 container treats 5,000 gal / 18,900 L

Alkalinity Booster with Phosphate Binder

9 lb / 4.08 kg

#96028

Packaged Weight: 9.8 lb

1 scoop treats 125 gal / 472 L

1 container treats 40,750 gal / 154,035 L

Sludge Fighting

NEW



Pond Sludge Remover Packs

- Eliminates and prevents pond sludge
- Water soluble packs make it easy to spot-treat and treat hard to reach areas
- Keeps rocks, gravel, and filters clean



Sludge & Filter Cleaner

- Biological pond and filter cleaner
- Contains 5 strains of heterotrophic bacteria
- Contains marigold and humic acid
- Safe for fish, plants, and animals



Sludge Cleaner Bubble Tabs

- Pond bottom and filter cleaner
- Bubble Tabs help disperse sludge-eating bacteria quickly
- Safe for fish, plants, or animals

Pond Sludge Remover Packs

18 Packs
#96081

Packaged Weight: 0.43 lb
1 pack treats 1,000 gal / 3,780 L
1 container treats 18,000 gal / 68,040 L

Sludge & Filter Cleaner

8 oz / 236 ml
#98889

Packaged Weight: 0.6 lb
1 pump treats 100 gal / 378 L
1 bottle treats 5,000 gal / 18,900 L

Sludge Cleaner Bubble Tabs

36 Tabs
#98901

Packaged Weight: 0.3 lb
1 tablet treats 100 gal / 378 L
1 container treats 3,600 gal / 13,608 L

Pond Sludge Remover Packs

32 Packs
#96084

Packaged Weight: 0.85 lb
1 pack treats 1,000 gal / 3,780 L
1 container treats 32,000 gal / 120,960 L

Sludge & Filter Cleaner

16 oz / 473 ml
#98890

Packaged Weight: 1.2 lb
1 pump treats 100 gal / 378 L
1 bottle treats 10,000 gal / 37,800 L

Sludge Cleaner Bubble Tabs

72 Tabs
#98902

Packaged Weight: 0.6 lb
1 tablet treats 100 gal / 378 L
1 container treats 7,200 gal / 27,216 L

Pond Sludge Remover Packs

72 Packs
#96082

Packaged Weight: 1.7 lb
1 pack treats 1,000 gal / 3,780 L
1 container treats 64,000 gal / 241,920 L

Sludge & Filter Cleaner

32 oz / 946 ml
#98891

Packaged Weight: 2.3 lb
1 pump treats 100 gal / 378 L
1 bottle treats 20,000 gal / 75,600 L

Sludge & Filter Cleaner

1 gal / 3.78 L
#98883

Packaged Weight: 9.2 lb
1 pump treats 600 gal / 2,268 L
1 bottle treats 80,000 gal / 302,400 L

Fountain Treatments



Patio Pond Maintenance Tabs

36 Tabs
#40004

Packaged Weight: 0.3 lb
1 tablet treats 100 gal / 378 L
1 container treats 3,600 gal / 13,608 L

- Targeted treatment for container water gardens
- Contains 8 pure strains of beneficial bacteria
- Helps optimize water quality
- Safe for fish, animals, and plants



Fountain Foam Free

8 oz / 236 ml
#98908

Packaged Weight: 0.6 lb
1 pump treats 10 gal / 37.8 L
1 bottle treats 500 gal / 1,890 L

- Safely eliminates foam from water features
- Helps maintain the beauty of your water feature
- Helps keep water clean and clear of foam
- Safe for animals



Rock & Fountain Cleaner

32 oz / 946 ml
#96055

Packaged Weight: 2.3 lb
1 bottle treats up to 300 sq. ft.

- Quickly eliminates debris from waterfalls, fountains, or streams
- Easy-to-use spray bottle application
- Safe for fish and plants

Fountain Treatments (Continued)



Fountain Maintenance

- Safely eliminates scale and debris build-up from water features
- Maintains the beauty of your water feature
- Helps maintain perfect water quality
- Prevents white scale build-up without damaging feature
- Safe for animals



Fountain Scale Free

8 oz / 236 ml

#98907

Packaged Weight: 0.6 lb

1 pump treats 10 gal / 37.8 L
1 bottle treats 500 gal / 1,890 L

- Safely removes calcium and scale from water features
- Helps keep water clean and clear of hard water deposits, white scale, and foam
- Adds the fresh clean scent of lavender
- Safe for animals

Fountain Maintenance

8 oz / 236 ml

#40007

Packaged Weight: 0.6 lb

1 pump treats 10 gal / 37.8 L
1 bottle treats 500 gal / 1,890 L

Fountain Maintenance

16 oz / 473 ml

#96056

Packaged Weight: 1.2 lb

1 pump treats 10 gal / 37.8 L
1 bottle treats 1,000 gal / 3,785 L

Fish Treatments



Pond Salt

- Reduces the effects of nitrite levels toxic to fish
- Helps restore natural electrolytes
- Repairs natural slime coat
- Prevents disease

Pond Salt

2 lb / 0.9 kg

#99416

Packaged Weight: 2 lb

1 scoop treats 190 gal / 718 L
1 container treats up to 1,520 gal / 5,745 L

Pond Salt

9 lb / 4.08 kg

#99417

Packaged Weight: 9 lb

1 scoop treats 190 gal / 718 L
1 container treats up to 6,840 gal / 25,835 L

Pond Salt

40 lb / 18.16 kg

#40003

Packaged Weight: 40 lb

1 scoop treats 190 gal / 718 L
1 container treats up to 30,400 gal / 114,912 L

Professional Grade Water Treatments

Aquascape Professional Grade Water Treatments are 25% more concentrated than the consumer equivalent.

- Measuring cups make it easy to apply larger doses
- Dosage guide on measuring cup for easy application



Beneficial Bacteria Professional Grade
1 gal / 3.78 L
#30406

Packaged Weight: 9 lb

1 scoop treats 6,000 gal / 22,680 L
1 bottle treats 96,000 gal / 362,880 L

- Provides clean, clear, and healthy water conditions
- Contains photosynthetic bacteria
- Contains marigold and vitamin B



Beneficial Bacteria Concentrate Professional Grade
9 lb / 4.08 kg
#30407

Packaged Weight: 9.3 lb

1 scoop treats 48,000 gal / 181,440 L
1 container treats 672,000 gal / 2,540,160 L

- Provides clean, clear, and healthy water conditions
- Contains 8 strains of bacteria
- Contains photosynthetic bacteria



Cold Water Beneficial Bacteria Professional Grade
1 gal / 3.78 L
#98895

Packaged Weight: 9 lb

1 scoop treats 6,000 gal / 22,680 L
1 bottle treats 96,000 gal / 362,880 L

- Provides clean, clear, and healthy water conditions
- Reduces ammonia, nitrite, and organic debris
- Ideal for use in water colder than 40°F (5°C)



Pond Starter Bacteria Professional Grade
1 gal / 3.78 L
#40011

Packaged Weight: 9 lb

1 scoop treats 6,000 gal / 22,712 L
1 container treats 96,000 gal / 363,400 L

- Establishes biological ecosystem
- Great for spring start-up and new ponds



Rapid Clear Flocculant Professional Grade
1 gal / 3.78 L
#30412

Packaged Weight: 9 lb

1 scoop treats 6,000 gal / 22,712 L
1 container treats 96,000 gal / 363,400 L L

- Clears discolored or cloudy water
- Clumps suspended debris (flocculation)
- Clears most ponds in 24 hours



Pond & Debris Clarifier Professional Grade
1 gal / 3.78 L
#40010

Packaged Weight: 9 lb

1 scoop treats 6,000 gal / 22,712 L
1 container treats 96,000 gal / 363,400 L

- Quickly cleans unsightly debris
- Restores water quality
- Reduces pond maintenance

Professional Grade Water Treatments (Continued)



SAB Stream & Pond Cleaner Professional Grade

9 lb / 4.08 kg

#30409

Packaged Weight: 9.3 lb

1 scoop treats 3,000 gal / 11,340 L

1 container treats 45,000 gal / 170,100 L

- Keeps ponds clean and crystal clear
- Reduces pond maintenance
- Reduces ammonia, nitrate, and phosphate binder



Waterfall & Rock Cleaner Professional Grade

9 lb / 4.08 kg

#30413

Packaged Weight: 9.3 lb

1 scoop treats 151-200 sq. ft.

1 container treats 3,650 sq. ft.

- Spot-treats the trouble areas on water features
- Quickly eliminates debris from waterfalls and rocks
- Reduces pond maintenance
- Goes to work instantly



Barley Straw Extract Professional Grade

1 gal / 3.78 L

#98906

Packaged Weight: 9 lb

1 scoop treats 6,000 gal / 22,680 L

1 bottle treats 96,000 gal / 362,880 L

- Natural way to clarify water
- Provides clear, clean pond conditions
- Starts working instantly
- Concentrated formulation with added enzymes



Ammonia Neutralizer Professional Grade

1 gal / 3.78 L

#40012

Packaged Weight: 9 lb

1 scoop treats 6,000 gal / 22,680 L

1 bottle treats 96,000 gal / 362,880 L

- Makes pond water safe for fish and plants
- Detoxifies chloramine in tap water
- Instantly neutralizes large concentrations of toxic ammonia



Pond Detoxifier Professional Grade

1 gal / 3.78 L

#30410

Packaged Weight: 9 lb

1 scoop treats 6,000 gal / 22,712 L

1 container treats 96,000 gal / 363,400 L

- Makes tap water safe for fish and plants
- Removes and detoxifies chlorine and chloramines
- Neutralizes ammonia
- Detoxifies and chelates copper and heavy metals



Sludge & Filter Cleaner Professional Grade

1 gal / 3.78 L

#30408

Packaged Weight: 9 lb

1 scoop treats 6,000 gal / 22,712 L

1 container treats 96,000 gal / 363,400 L

- Biological pond and filter cleaner
- Contains 5 strains of heterotrophic bacteria
- Contains marigold and humic acid

Lake and Large Pond Treatments

Aquascape Lake and Large Pond Treatments are intended for lake and large pond use only. These formulations are optimized specifically for larger bodies of water and can cause issues when used in smaller water features.

NEW



Lake Sludge Remover Packs

- Quickly eliminates organic sludge and muck
- Easy-to-use water soluble packs make it easy to spot-treat and treat hard to reach areas
- All active ingredients with no fillers or binders
- Slowly releases oxygen to maximize sludge reduction
- Added macrobiotics and carbon source

Lake Sludge Remover Packs
192 Packs
#40017

Packaged Weight: 4 lb

One pack treats approximately 250 ft.²

One container treats approximately 48,000 ft.²

NEW



Lake Blue Dye Packs

- Shades and protects water to prevent/eliminate water quality issues
- Easy-to-use water soluble packs make it easy to treat hard to reach areas
- Significantly reduces maintenance, filters sunlight, and cools water temperature
- Helps hide fish from predators

Lake Blue Dye Packs
2 Packs
#40020

Packaged Weight: 0.5 lb

One pack treats up to 1.5 acre foot

One container treats up to 3 acre feet

NEW



Lake Phosphate Binder Packs

- Quickly binds phosphates to clean and clear water
- Easy-to-use water soluble packs make it easy to treat hard to reach areas
- Prevents and eliminates floating debris and debris that attaches to rocks and gravel
- Significantly reduces maintenance
- Binds orthophosphate

Lake Phosphate Binder Packs
192 Packs
#40024

Packaged Weight: 4 lb

One pack treats approximately 250 ft.²

One container treats approximately 48,000 ft.²

Lake Sludge Remover Packs
384 Packs
#40018

Packaged Weight: 8 lb

One pack treats approximately 250 ft.²

One container treats approximately 96,000 ft.²

Lake Blue Dye Packs
4 Packs
#40021

Packaged Weight: 1 lb

One pack treats up to 1.5 acre foot

One container treats up to 6 acre feet

Lake Phosphate Binder Packs
384 Packs
#40025

Packaged Weight: 8 lb

One pack treats approximately 250 ft.²

One container treats approximately 96,000 ft.²

Lake Sludge Remover Packs
1,152 Packs
#40019

Packaged Weight: 24 lb

One pack treats approximately 250 ft.²

One container treats approximately 288,000 ft.²

Lake Blue Dye Packs
16 Packs
#40022

Packaged Weight: 4 lb

One pack treats up to 1.5 acre foot

One container treats up to 24 acre feet

Lake Phosphate Binder Packs
1,152 Packs
#40026

Packaged Weight: 24 lb

One pack treats approximately 250 ft.²

One container treats approximately 288,000 ft.²

NEW



Lake Treatment Booster Packs

- Turbo boosts the effects of lake water treatments
- Easy-to-use water soluble packs make it easy to spot-treat and treat hard to reach areas
- Adds oxygen and elements directly to the water to accelerate nutrient uptake and sludge digestion
- Increases bacterial growth by up to ten times
- Ideal for use with Lake Sludge Remover Packs, Lake Bacteria Packs, and Lake Phosphate Binder Packs
- Great for non-aerated or highly eutrophic bodies of water

Lake Treatment Booster Packs

192 Packs
#40027

Packaged Weight: 4 lb

One pack treats approximately 250 ft.²

One container treats approximately 48,000 ft.²

Lake Treatment Booster Packs

384 Packs
#40028

Packaged Weight: 8 lb

One pack treats approximately 250 ft.²

One container treats approximately 96,000 ft.²

Lake Treatment Booster Packs

1,152 Packs
#40029

Packaged Weight: 24 lb

One pack treats approximately 250 ft.²

One container treats approximately 288,000 ft.²

NEW



Lake Flocculant Clarifier

1 gal
#40023

Packaged Weight: 9.2 lb

One gallon treats 1/4 acre for 1-3 months

- Quickly clears cloudy water caused by suspended particles
- Optimized to clarify clay, mineral material, and sediment issues
- Significantly reduces maintenance

NEW



Lake Bacteria Packs

- Restores the ecosystem, keeping water clean, clear, and healthy
- Easy-to-use water soluble packs make it easy to treat hard to reach areas
- Significantly reduces maintenance
- Fortified with prebiotics to enhance water quality

Lake Bacteria Packs

24 Packs
#40013

Packaged Weight: 3 lb

Four packs treat 1/4 acre for one month

One container treats up to 1.5 acres

Lake Bacteria Packs

48 Packs
#40014

Packaged Weight: 6 lb

Four packs treat 1/4 acre for one month

One container treats up to 3 acres

Lake Bacteria Packs

192 Packs
#40015

Packaged Weight: 24 lb

Four packs treat 1/4 acre for one month

One container treats up to 12 acres

NEW



Lake Bacteria

1 gal
#40016

Packaged Weight: 9.2 lb

One gallon treats 1/4 acre for 1-3 months

- Restores the ecosystem, keeping water clean, clear, and healthy
- Significantly reduces maintenance
- Fortified with prebiotics to enhance water quality



PREDATOR CONTROL

Pond fish can be vulnerable to a variety of predators, including large birds such as the pesky blue heron. Fortunately, Aquascape provides several products to help pond owners prevent predators from harming their prized fish. Our popular ornamental deterrents help keep koi and other pond fish safe.



Floating Alligator Decoy
#93000

Packaged Weight: 2 lb

Add a little fun to your pond while protecting your valuable fish. The natural body movement will deter herons and other predators from visiting your pond.

- Three hinged body parts allow gator to float freely and appear lifelike, deterring pond predators
- Detailed in non-fading, no-glare, all-weather paint



Blue Heron Decoy
#81030

Packaged Weight: 32.7 lb

Product Dimensions: 25"L x 7"W x 26.5"H

Deter herons from coming to your pond by tricking them into thinking another heron is already there.

- Looks life-like
- Quick and easy set-up
- Hand-painted with non-fading, no-glare, all-weather paint
- Surface treated to prevent paint flaking
- Molded from durable, lightweight polymer



SEASONAL CARE

Selecting Your Seasonal Care Products

The following components are vital to ensure that your water feature is properly maintained and your fish are cared for in the colder months of the year.

Cold Water Beneficial Bacteria (for spring and fall) — see page 67 for more information

Beneficial bacteria living in the biological filter and throughout the rocks and gravel in the pond are a key component to achieving crystal clear water and reducing pond maintenance. The bacteria, similar to aquatic plants, consume excess nutrients but are also capable of breaking down organic debris. It is important to the pond's ecosystem for these maintenance microbes to become established as early in the spring as possible. Aquascape Cold Water Beneficial Bacteria is perfect for both spring and fall because it works at temperatures below 40°F and contains pure strains of concentrated beneficial bacteria that go to work quickly, cleaning and balancing your pond.

Premium Cold Water Fish Food (for spring and fall) — see page 83 for more information

In the colder months of the year, when the water temperature is below 60°F, your fish's metabolism slows down in preparation for hibernation. It is important during these times to either eliminate fish feeding from your daily regimen or switch to a food that is formulated for low water temperatures. Aquascape Premium Cold Water Fish Food is scientifically formulated to provide quality nutrition to all pond fish, including goldfish and koi. The inclusion of spirulina and wheat germ helps make the food easier to digest in colder water temperatures.

AquaForce® — see page 38 for more information

In the colder months, it is important to start thinking about protecting your fish by ensuring that there's a hole open in the ice all winter long. Our AquaForce® pump is a recirculating bubbler pump designed to sit in the pond and oxygenate the water. The flow from the pump will bubble at the surface of the pond and maintain an opening in the ice. By keeping a hole open in the ice, you keep the water oxygenated and allow gases to escape.

Pond Aeration — see page 48 for more information

Pond aerators can be positioned 1.5–2 feet below the surface of the pond to maintain a hole in surface ice and provide additional oxygenation for the colder seasons.

Seasonal Care



300-Watt Pond De-Icer #39000

Packaged Weight: 3 lb

AquaScaper 300-Watt Pond De-Icer is ideal for keeping a small opening in the ice during cold winter months to ensure proper gas exchange and help keep fish alive during the winter.

- Helps increase pond oxygen levels
- Stainless steel construction prevents corrosion and cracking
- Low cost to operate
- Built-in LED light indicates when heater is in use



Features of the 300-Watt Pond De-Icer

- ① High quality stainless steel housing
- ② LED light indicates when the unit is operating



Submersible Pond Thermometer #74000

Packaged Weight: 0.2 lb

Monitor pond temperature throughout the year to adjust fish feeding and water treatment applications during seasonal changes.

Protective Pond Netting



Protective Pond Netting

AquaScaper Protective Pond Netting keeps predators out while catching leaves and falling debris before they enter the pond. The reusable netting is easy to install and resists tearing. Each net comes complete with landscape stakes, making it simple and easy to cover your water feature.

- Keeps falling leaves and debris from entering the pond
- Protects fish from predators
- Comes complete with stakes to secure netting into place
- Quality woven poly material is reusable and resists tearing

Protective Pond Netting 7' x 10' #98000

Packaged Weight: 0.6 lb
Packaged Dimensions: 5.5"L x 3"W x 9"H

Protective Pond Netting 14' x 20' #98001

Packaged Weight: 1.1 lb
Packaged Dimensions: 7.25"L x 4.75"W x 15"H

Protective Pond Netting 28' x 30' #98002

Packaged Weight: 2.3 lb
Packaged Dimensions: 10.5"L x 5"W x 21.5"H

Bulk Protective Pond Netting

NEW



Bulk Protective Pond Netting

- Ideal for multiple installations or larger ponds
- Markers every 5' make it easy to cut to proper size
- Easy-to-dispense box makes it easy to cut a net for most pond sizes
- Fine 3/8" mesh keeps out smaller debris

Bulk Protective Pond Netting
10' x 100'
#74007

Bulk Protective Pond Netting
20' x 100'
#74002

Bulk Protective Pond Netting
30' x 100'
#74003

Protective Pond Netting Accessories

NEW



U-Shaped Ground Stakes

100 pieces

#74008



FISH CARE

Fish, like all creatures, need healthy, nutrient-rich food to thrive. Aquascape fish foods contain probiotics that aid in digestion, optimize growth rates, and reduce fish waste. Quality ingredients, including multivitamins and stabilized vitamin C, provide superior nutrition and will not pollute pond water. Aquascape fish foods are scientifically formulated to provide all pond fish, including koi and goldfish, premium quality nutrition at an affordable price.

- Floating pellet ideal for all pond fish
- Keeps pond water clean and clear
- Includes stabilized multivitamin and probiotics
- Will not break apart and cloud water
- Contains high-quality protein

Premium Staple Fish Food Pellets



Premium Staple Fish Food Pellets
Formulated for everyday use.

Premium Staple Fish Food Pellets 1.1 lb / 500 g #98867 Small Pellets	Premium Staple Fish Food Pellets 2.2 lb / 1 kg #98868 Medium Pellets	Premium Staple Fish Food Pellets 4.4 lb / 2 kg #98869 Large Pellets
Premium Staple Fish Food Pellets 11 lb / 5 kg #81049 Large Pellets	Premium Staple Fish Food Pellets 22 lb / 10 kg #81007 Large Pellets	Premium Staple Fish Food Pellets 44 lb / 20 kg #50003 Large Pellets
Premium Staple Fish Food Pellets 1.1 lb / 500 g #81050 Mixed Pellets (small, medium, large)	Premium Staple Fish Food Pellets 2.2 lb / 1 kg #81051 Mixed Pellets (small, medium, large)	Premium Staple Fish Food Pellets 4.4 lb / 2 kg #81052 Mixed Pellets (small, medium, large)
	Premium Staple Fish Food Pellets 11 lb / 5 kg #81053 Mixed Pellets (small, medium, large)	

Premium Cold Water Fish Food Pellets



Premium Cold Water Fish Food Pellets
Formulated to be fed at temperatures as low as 50°F/10°C.

Premium Cold Water Fish Food Pellets 1.1 lb / 500 g #98870 Small Pellets	Premium Cold Water Fish Food Pellets 2.2 lb / 1 kg #98871 Medium Pellets	Premium Cold Water Fish Food Pellets 4.4 lb / 2 kg #98872 Large Pellets
Premium Cold Water Fish Food Pellets 11 lb / 5 kg #81047 Large Pellets	Premium Cold Water Fish Food Pellets 22 lb / 10 kg #81003 Large Pellets	Premium Cold Water Fish Food Pellets 44 lb / 20 kg #81004 Large Pellets

Premium Color Enhancing Fish Food Pellets



Premium Color Enhancing Fish Food Pellets

Formulated to promote brilliant colors for all pond fish.

<p>Premium Color Enhancing Fish Food Pellets 1.1 lb / 500 g #98873</p> <p>Small Pellets</p>	<p>Premium Color Enhancing Fish Food Pellets 2.2 lb / 1 kg #98874</p> <p>Medium Pellets</p>	<p>Premium Color Enhancing Fish Food Pellets 4.4 lb / 2 kg #98875</p> <p>Large Pellets</p>
<p>Premium Color Enhancing Fish Food Pellets 44 lb / 20 kg #81006</p> <p>Large Pellets</p>	<p>Premium Color Enhancing Fish Food Pellets 22 lb / 10 kg #81005</p> <p>Large Pellets</p>	<p>Premium Color Enhancing Fish Food Pellets 11 lb / 5 kg #81048</p> <p>Large Pellets</p>

Fish Food



Koi Krunchies

14.1 oz / 400 g
#81000

Packaged Weight: 1.1 lb

Aquascape Koi Krunchies are a wonderful addition to your fish's regular diet and are ideal for hand feeding goldfish, koi, and other pond fish. Aquascape Koi Krunchies contain real fruit flavors and are a great source of vitamin C, which is linked to proper tissue formation, proper digestion, and disease resistance.

- Great for hand feeding all pond fish
- Contains quality, natural ingredients
- Low waste



Premium Fish Food Flakes





4.2 oz / 119 g
#98878

Packaged Weight: 0.4 lb

Aquascape Premium Fish Food Flakes are scientifically formulated to provide premium nutrition to all pond fish including goldfish and koi. The inclusion of plankton and shrimp meal help make this food irresistible to pond fish, including smaller fish and babies known as fry.

- Keeps pond water clean and clear
- Includes stabilized multivitamin
- Will not break apart and cloud water
- Contains high-quality protein
- Promotes brilliant colors on all pond fish

Premium Fish Food Pellets Chart

Pellet Size	Recommendation
 Small Pellet 2.5–3.5 mm	Ideal for small fish from 3" (8 cm) and above
 Medium Pellet 4.5–5.5 mm	Ideal for medium fish from 7" (18 cm) and above
 Large Pellet 6.5–7.5 mm	Ideal for large fish from 8" (20 cm) and above
 Mixed Pellet 2.5–7.5 mm	Ideal for all size fish from 3" (8 cm) and above

Nets

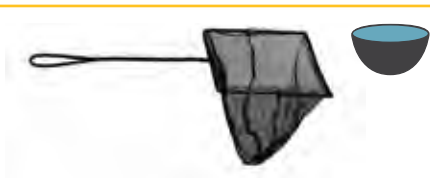

Kid's Pond Explorer Net
#98556

Packaged Weight: 0.2 lb
10" x 7" with 12" Handle

Provides kids with a fun way to interact with water feature.



Pond Net with Extendable Handle
#98558

Packaged Weight: 0.6 lb
32" handle, extends to 63"

This small 12" x 7" net is designed for general maintenance and handling pond fish.



Pond Skimmer Net with Extendable Handle
#98559

Packaged Weight: 0.6 lb
32" handle, extends to 63"

This small 12" x 7" net is great for scooping up debris in tight spaces.



Collapsible Pond and Fish Net
17" Black Coarse Mesh
#81031

Packaged Weight: 1.1 lb
Ideal net for catching and handling fish.



Collapsible Pond Skimmer Net
17" White Fine Mesh
#81032

Packaged Weight: 1.1 lb
Ideal for quick and easy removal of leaves and other debris.



NEW

Pond Shark
#74004

Packaged Weight: 1.1 lb
Extends up to 60"

Versatile pond net with innovative raking and scraping blades.

Professional Nets



Heavy Duty Pond Net with Extendable Handle
#98560

Packaged Weight: 1.4 lb
36" handle, extends to 69"

Great for general maintenance, handling larger pond fish, and removing large amounts of debris, cutting down on maintenance time.



Heavy Duty Pond Skimmer Net with Extendable Handle
#98562

Packaged Weight: 1.4 lb
36" handle, extends to 63"

Great for effectively removing large amounts of debris, cutting down on maintenance time.



Professional Fish Net with Extendable Handle
#98561

Packaged Weight: 2.1 lb
22" diameter head, 32" handle, extends to 69"

Super soft netting and shallow design specifically designed to handle and cradle larger pond fish including koi preventing them from being snagged in the mesh.



Professional Grade Pond Net
#50000

Packaged Weight: 2 lb
Great for handling large fish and general maintenance.



Professional Grade Pond Skimmer Net
#50001

Packaged Weight: 2 lb
Ideal for removing small floating and suspended debris from the pond water.



NEW

Pond Shark Pro
#74005

Packaged Weight: 1.1 lb
Extends up to 96"

Versatile, professional-quality pond net with innovative raking and scraping blades.

Fish Treatments



Pond Salt

2 lb / 0.9 kg

#99416

Packaged Weight: 2 lb

1 scoop treats 190 gal / 718 L

1 container treats up to 1,520 gal / 5,745 L

- Reduces the effects of nitrite levels toxic to fish
- Helps restore natural electrolytes
- Repairs natural slime coat
- Prevents disease



Pond Salt

9 lb / 4.08 kg

#99417

Packaged Weight: 9 lb

1 scoop treats 190 gal / 718 L

1 container treats up to 6,840 gal / 25,835 L

- Reduces the effects of nitrite levels toxic to fish
- Helps restore natural electrolytes
- Repairs natural slime coat
- Prevents disease



Pond Salt

40 lb / 18.16 kg

#40003

Packaged Weight: 40 lb

1 scoop treats 190 gal / 718 L

1 container treats up to 30,400 gal / 114,912 L

- Reduces the effects of nitrite levels toxic to fish
- Helps restore natural electrolytes
- Repairs natural slime coat
- Prevents disease



AQUATIC PLANT CARE

Aquatic plants are an important part of the water garden. They provide beauty and naturalization with a huge array of plant choices. Most importantly, they help balance the pond's ecosystem and provide valuable biological filtration that removes nitrogen, ammonia, nitrates, and other minerals from pond water. These excess nutrients are often the cause of unsightly water conditions. The end result helps to minimize pond maintenance, leaving more time to enjoy your pond. Without aquatic plants, your pond would not be able to function as a complete ecosystem.

Pond plants can be classified into a few main categories: waterlilies, marginal plants, floaters, and oxygenators. Plants can also be put into two basic types known as "tropical" and "hardy." Hardy plants will over-winter in colder climates and tropical plants are more suited to warmer climates, although tropical plants are often used as annuals in colder climate zones.

Floating Plant Island



Floating Plant Island
#89006

Packaged Weight: 0.4 lb
Dimensions: 15"L x 11"W x 4"H

The AquaScape Floating Plant Island is ideal for displaying plants in deeper areas of the pond or where there are no plant shelves. The floating planter keeps the soil intact and lets water in while protecting plants from fish. Constructed to stay afloat at the surface of the pond, the Floating Plant Island provides stunning options for displaying plants within the pond.

Aquatic Planters

AquaScape Aquatic Planters are ideal for all pond plants. Made from fine, porous material, the planters allow water in while preventing soil from entering your pond. The flexibility of Aquatic Planters makes it simple to place plants between rocks and other form-fitting areas. Aquatic Planters blend into their surroundings and will not break or crack like traditional plastic planters.

- Can be molded to fit in tight spaces
- Will not break or crack
- Keeps soil from escaping



Aquatic Planter 6" x 6"
(2-pack)
#98501

Packaged Weight: 0.1 lb
Packaged Dimensions: 6.5"L x 7"W x 1"H



Aquatic Planter 8" x 6"
(2-pack)
#98502

Packaged Weight: 0.1 lb
Packaged Dimensions: 11.5"L x 8"W x 1"H



Aquatic Planter 12" x 8"
(2-pack)
#98500

Packaged Weight: 0.1 lb
Packaged Dimensions: 12"L x 8"W x 1"H



Aquatic Lily Planter 14" x 7"
(2-pack)
#98929

Packaged Weight: 0.1 lb
Packaged Dimensions: 12"L x 9.5"W x 1"H

Pond Plant Potting Media

This all-natural, non-toxic alluvial planting media is fine-grained and perfect for supporting the growth of aquatic plants. Our premium potting media contains no peat moss or compost and is safe for fish.



Pond Plant Potting Media
215 cubic inches / 0.0035 cubic meters
#89002



Pond Plant Potting Media
432 cubic in / 0.007 cubic meters
#89003

Pond Plant Fertilizer



Once-A-Year Pond Plant Fertilizer
13-13-13

Aquascape Once-A-Year Pond Plant Fertilizer contains a complete time-released fertilizer that will help maximize plant growth and increase flower production all in a single application.

Once-A-Year Pond Plant Fertilizer 13-13-13
1.1 lb / 500 g
#98916

Packaged Weight: 1.2 lb
Packaged Dimensions: 3"L x 3"W x 6.25"H

Once-A-Year Pond Plant Fertilizer 13-13-13
7 lb / 3.2 kg
#98917

Packaged Weight: 7.8 lb
Packaged Dimensions: 7.5"L x 7.5"W x 7.75"H



DECORATIVE

Decorative Water Features

Decorative water features include Fire Fountains, container water gardens, stand-alone fountains, bubbling rocks or urns, spitters, and any fountain that incorporates an in-ground reservoir.

Fire Fountains

Fire fountains combine the beauty and elegance of fire and flowing water in a durable, self-contained GFRC (glass fiber reinforced concrete) water feature that sets up in minutes.

Container Water Gardens

Container water gardens are great for people who do not have the space or budget for an ecosystem pond, providing a way to add a miniature pond to any location.

Decorative Spitters

Decorative spitters are often used to add a whimsical touch or create a focal point and water movement to existing ponds or container water gardens. Decorative spitters can also be incorporated into traditional landscapes when combined with a small reservoir or AquaBasin® Mini.

Bubbling Stone Fountains and Spillway Bowls

These larger water features are typically set atop an underground reservoir known as an AquaBasin®. A water pump contained within the AquaBasin keeps circulating the water over the feature.

Fire Fountains

The Aquascape Fire Fountain provides the beauty and elegance of fire and flowing water in a bowl-shaped GFRC water feature. The self-contained water feature sets up in minutes. A fire feature in the center makes this fountain an ideal focal point or centerpiece to any outdoor setting.



Fire Fountain 24"

#78201

Packaged Weight: 56 lb
Dimensions: 24" diameter x 12"H



Fire Fountain 28"

#78202

Packaged Weight: 72 lb
Dimensions: 28" diameter x 14"H



Fire Fountain 32"

#78203

Packaged Weight: 96 lb
Dimensions: 32" diameter x 16"H

Fire Glass



1/4" Reflective Black
Fire Glass

#78262

Packaged Weight: 10 lb
Packaged Dimensions: 6"L x 4"W x 8.5"H



1/4" Reflective Cobalt Blue
Fire Glass

#78263

Packaged Weight: 10 lb
Packaged Dimensions: 6"L x 4"W x 8.5"H



1/4" Aquamarine
Fire Glass

#78264

Packaged Weight: 10 lb
Packaged Dimensions: 6"L x 4"W x 8.5"H

Fire Fountain Add-On Kits



Fire Fountain Add-On Kit
for Stacked Slate Fountains

#78221

Packaged Weight: 4.5 lb
Packaged Dimensions: 10.5"L x 10.5"W x 7.5"H



Fire Fountain Add-On Kit
for Scalloped Urns

#78260

Packaged Weight: 4.5 lb
Packaged Dimensions: 10.5"L x 10.5"W x 7.5"H



Fire Fountain Add-On Kit
for Rippled Urns

#78267

Packaged Weight: 4.5 lb
Packaged Dimensions: 10.5"L x 10.5"W x 7.5"H

Aquatic Patio Pond Kit



Aquatic Patio Pond Kit

#78197

Packaged Weight: 9 lb

Add the beauty of water to your garden, deck, patio, or balcony.

Kit Includes:

- 16" Square Textured Gray Slate Patio Pond
- Pouring Bamboo Fountain with pump

Patio Ponds

Aquascape Patio Ponds make it simple to have a complete water garden in almost any setting. Creating a beautifully planted water bowl or container water garden has never been easier. Aquascape Patio Ponds have all the natural beauty of real rock with the added durability and lightweight of fiberglass. Create a natural paradise with Aquascape Patio Ponds.

- Lightweight and durable
- Can be used indoors or outdoors
- Never fade or chips
- Natural rock veneer
- Ages like real stone
- Integrated plant shelves



Textured Gray Slate 22"
Patio Pond

15 gallons

#78049

Packaged Weight: 19 lb
Dimensions: 22"L x 22"W x 12"H



Textured Gray Slate 27"
Patio Pond

27 gallons

#78050

Packaged Weight: 24 lb
Dimensions: 27"L x 27"W x 14"H



Textured Gray Slate 33"
Patio Pond

45 gallons

#78051

Packaged Weight: 34.5 lb
Dimensions: 33"L x 33"W x 16"H

Patio Ponds (Continued)



Green Slate 24" Patio Pond

10 gallons

#98853

Packaged Weight: 19.5 lb
Dimensions: 24"L x 24"W x 12"H



Green Slate 32" Patio Pond

20 gallons

#98856

Packaged Weight: 29 lb
Dimensions: 32"L x 32"W x 14"H



Green Slate 40" Patio Pond

30 gallons

#98859

Packaged Weight: 51 lb
Dimensions: 40"L x 40"W x 16"H



Desert Granite 24" Patio Pond

10 gallons

#98854

Packaged Weight: 19.5 lb
Dimensions: 24"L x 24"W x 12"H



Desert Granite 32" Patio Pond

20 gallons

#98857

Packaged Weight: 29 lb
Dimensions: 32"L x 32"W x 14"H



Desert Granite 40" Patio Pond

30 gallons

#98860

Packaged Weight: 51 lb
Dimensions: 40"L x 40"W x 16"H



European Terra Cotta 24"
Patio Pond

10 gallons

#98855

Packaged Weight: 19.5 lb
Dimensions: 24"L x 24"W x 12"H



European Terra Cotta 32"
Patio Pond

20 gallons

#98858

Packaged Weight: 29 lb
Dimensions: 32"L x 32"W x 14"H



European Terra Cotta 40"
Patio Pond

30 gallons

#98861

Packaged Weight: 51 lb
Dimensions: 40"L x 40"W x 16"H

Decorative Media and Fountain Accessories



Decorative River Pebbles—
Black

#78160

Packaged Weight: 22 lb

- Each bag covers approximately 1.5 sq. ft. of surface



Decorative River Pebbles—
Mixed

#78161

Packaged Weight: 22 lb

- Each 22 lb. bag covers approximately 1.5 sq. ft. of surface



Fountain Shims

(set of 6)

#78159

Packaged Weight: 2.1 oz)
Dimensions: 4.5"L x 0.75"W

- Ideal for leveling resin, concrete, stone, or GFRC water fountains.

AquaRock Fountain Kits

Incorporate the sights and sounds of water into any location with Aquascape AquaRock Fountain Kits. Kits are available in two colors and come complete with everything needed to install a beautiful water fountain.

- Simple to install and maintain (most installations take less than 1 hour)
- Integrates easily into existing landscapes
- Comes complete with all necessary components
- Fountain is made from real rock (stone size and quantity may vary)
- Hand crafted and made in the USA



AquaRock Sandstone Fountain Kit
#97068

Packaged Weight: 45 lb
Packaged Dimensions: 12" diameter x 14.5"H

Kit Includes:

- Five gallon bucket (water basin) and perforated lid
- Lid liner skirt
- Water pump with 6' power cord
- Water hose
- Drilled Sandstone Rock



AquaRock Blue Stone Fountain Kit
#97067

Packaged Weight: 45 lb
Packaged Dimensions: 12" diameter x 14.5"H

Kit Includes:

- Five gallon bucket (water basin) and perforated lid
- Lid liner skirt
- Water pump with 6' power cord
- Water hose
- Drilled Blue Stone Rock

Polyresin Decorative Spitters

Aquascape decorative spitters are made from high quality, sturdy, polyresin that is lightweight as well as UV and heat resistant. Polyresin takes on the texture, shape, and finish of real brass, wood, and stone at a fraction of the cost and maintenance.



Deer Scarer
Bamboo Fountain
#78306

Packaged Weight: 2.6 lb
Dimensions: 5"L x 5"W x 15"H

Recommended:

90 GPH Water Pump #91024



Pouring 3-Tier
Bamboo Fountain
#78307

Packaged Weight: 2.6 lb
Dimensions: 5"L x 5"W x 15"H

Recommended:

90 GPH Water Pump #91024

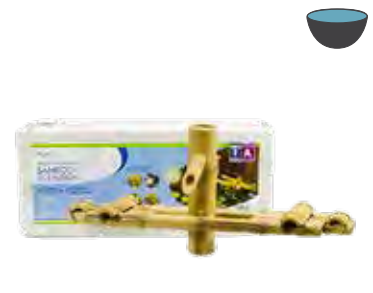

Adjustable Pouring
Bamboo Fountain
#78308

Packaged Weight: 3.5 lb
Dimensions: 5"L x 5"W x 15"H
Extends from 18" to 30"

Recommended:

90 GPH Water Pump #91024

Polyresin Decorative Spitters (Continued)



Alligator Spitter
#78302

Packaged Weight: 11 lb
Dimensions: 19"L x 11"W x 12"H
Recommended:
180 GPH Water Pump #91025



Dragonfly Spitter
#78303

Packaged Weight: 12 lb
Dimensions: 12"L x 11"W x 25"H
Recommended:
180 GPH Water Pump #91025



Double Frog with Cattail Spitter
#78304

Packaged Weight: 10 lb
Dimensions: 10"L x 10"W x 18"H
Recommended:
180 GPH Water Pump #91025



Frog on Reed Spitter
#78305

Packaged Weight: 9 lb
Dimensions: 12"L x 9"W x 18"H
Recommended:
180 GPH Water Pump #91025



Lazy Frog on Lily Pad Spitter
#78311

Packaged Weight: 2.6 lb
Dimensions: 12"L x 10"W x 5"H
Recommended:
90 GPH Water Pump #91024



Naughty Dog Spitter
#78310

Packaged Weight: 5.3 lb
Dimensions: 18.5"L x 10"W x 10.5"H
Recommended:
90 GPH Water Pump #91024



Crazy Legs Frog Spitter
#78312

Packaged Weight: 5.5 lb
Dimensions: 37"L x 8"W x 20"H
Recommended:
90 GPH Water Pump #91024



Crane with Lowered Head Spitter
#78313

Packaged Weight: 11 lb
35"H
Recommended:
180 GPH Water Pump #91025



Standing Crane Spitter
#78314

Packaged Weight: 11 lb
41"H
Recommended:
180 GPH Water Pump #91025



Toucan Spitter
#78309

Packaged Weight: 7.3 lb
Dimensions: 9"L x 18"W x 18"H
Recommended:
90 GPH Water Pump #91024

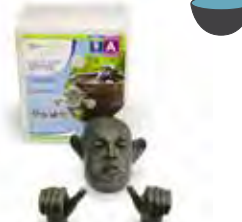

Man in Barrel Spitter
#78315

Packaged Weight: 3 lb
Package Dimensions: 4"L x 9"W x 5"H
Head Dimensions: 8.5"L x 11"W x 8"H
Hand Dimensions: 4.5"L x 5"W x 3"H
Recommended:
90 GPH Water Pump #91024

* barrel not included statment

AquaBasin® Mini Fountains and Fountain Kits

Aquascape AquaBasin® Mini Fountains and Fountain Kits include everything you need to add an elegant water feature to any backyard or landscape. Each kit comes complete with water pump, AquaBasin® Mini reservoir, tubing, and your choice of decorative fountain.



Leaning Vase Fountain
#98920

Packaged Weight: 5.5 lb
Dimensions: 11"L x 11"W x 16"H



Leaning Vase Fountain Kit
#98921

Packaged Weight: 12.7 lb
Packaged Dimensions: 27"L x 22"W x 15"H



Swirly Vase Fountain
#58019

Packaged Weight: 6 lb
Dimensions: 9"L x 9"W x 13"H



Swirly Vase Fountain Kit
#58054

Packaged Weight: 13 lb
Packaged Dimensions: 27"L x 22.25"W x 15.25"H



Amphora Vase Fountain
#98922

Packaged Weight: 4.3 lb
Dimensions: 11"L x 11"W x 16"H



Amphora Vase Fountain Kit
#98923

Packaged Weight: 11.6 lb
Packaged Dimensions: 27"L x 22.25"W x 15.25"H



Mini Stacked Slate Urn Fountain
#58014

Packaged Weight: 5 lb
Dimensions: 9.75"L x 9.75"W x 13.75"H



Mini Stacked Slate Urn Fountain Kit
#58060

Packaged Weight: 12 lb
Packaged Dimensions: 30"L x 30"W x 10"H

Landscape Fountain Kits



Spillway Bowl and Basin
Landscape Fountain Kit

#58087

See page 99 for more information.



Pagoda Fountain Rocks Set of 3
Landscape Fountain Kit

#58086

See page 99 for more information.



Mongolian Basalt Column 30"
Landscape Fountain Kit

#58065

See page 100 for more information.



Mongolian Basalt Columns Set
of 3 Landscape Fountain Kit

#58089

See page 100 for more information.



Stacked Slate Spillway Wall 32"
Landscape Fountain Kit

#78269

See page 102 for more information.



Medium Stacked Slate Sphere
Landscape Fountain Kit

#78290

See page 101 for more information.



Medium Stacked Slate Urn
Landscape Fountain Kit

#58090

See page 104 for more information.



Medium Scalloped Urn
Landscape Fountain Kit

#78270

See page 105 for more information.



Medium Rippled Urn
Landscape Fountain Kit

#78271

See page 105 for more information.

Backyard Waterfall Landscape Fountain Kit



Backyard Waterfall Landscape Fountain Kit #83013C

Packaged Weight: 147 lb

Kit Includes:

- Waterfall Spillway
- AquaBasin® 45
- Pre-cut EPDM Liner—7.5' x 7.5'
- Flexible PVC Pipe—1.5" x 15'
- AquaSurge® 2000 Pond Pump
- AquaSurge® Low Suction Intake Attachment
- Installation Kit
 - Fittings
 - Silicone Sealant
 - Pond and Waterfall Foam Sealant
- Welcome Kit

Backyard Waterfall Landscape Fountain Kit Application

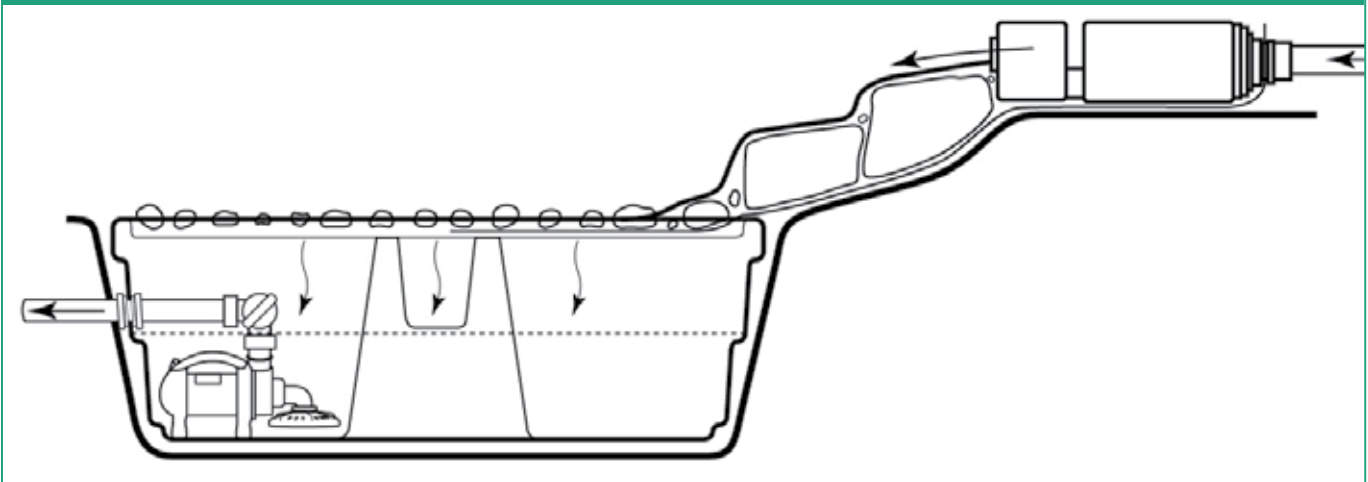

Spillway Bowl, Basin, and Stand

The Aquascape Spillway Bowl, Basin, and Stand have a beautiful and unique patina made from durable GFRC (glass fiber reinforced concrete). They are lightweight and easy to install in unlimited possibilities. Install them as a disappearing water feature or link several together for an inspired display. The stands create the ideal elevation between the bowl and basin.



Spillway Bowl 32"
#78204

Packaged Weight: 71 lb
Dimensions: 32"L x 32"W x 14.5"H
Recommended Pump:
Ultra 2000 Water Pump #91010



Spillway Basin 40"
#78205

Packaged Weight: 141 lb
Dimensions: 40"L x 40"W x 16"H
Recommended Pump:
Ultra 2000 Water Pump #91010



Spillway Bowl Stand
(2-pack)
#78206

Packaged Weight: 33.5 lb
Dimensions: 13.5"L x 13.5"W x 4"H



Spillway Bowl and Basin
Landscape Fountain Kit
#58087

Packaged Weight: 334 lb
Kit Includes:

- Spillway Bowl
- Spillway Basin
- (2) Spillway Stands
- AquaBasin® 45
- Pre-cut Kink-Free Pipe 3/4" x 12.5'
- Ultra 2000 Water Pump

Pagoda Fountain Rocks

These beautiful, stratified limestone rocks have incredible foliation and one-of-a-kind shape and character that provide a beautiful rippling effect as water cascades over the surface of the stones.



Pagoda Fountain Rocks Set of 3
#78219

Approx. Packaged Weight: 482 lb
Includes:
(1)—small pagoda rock
(1)—medium pagoda rock
(1)—large pagoda rock
Recommended Pump:
Ultra 2000 Water Pump #91010



Pagoda Fountain Rocks Set of 3
Landscape Fountain Kit
#58086

Approx. Packaged Weight: 594 lb
Kit Includes:

- Pagoda Fountain Rocks Set of 3
- AquaBasin® 45
- Pond and Waterfall Foam Sealant
- Pre-cut Kink-Free Pipe 3/4" x 12.5'
- Ultra 2000 Water Pump

Stone Basalt Columns

These natural stones provide impressive sights and sounds as water tumbles from the tall columns. The amazing variation and texture options ensure there is a basalt column perfect for any location.



Natural Mongolian Basalt Column 24"

#58038

Approx. Packaged Weight: 200 lb
Dimensions: 10" diameter x 24"H

Recommended Pump:

Ultra 550 Water Pump #91006



Natural Mongolian Basalt Column 30"

#98503

Approx. Packaged Weight: 335 lb
Dimensions: 10" diameter x 30"H

Recommended Pump:

Ultra 1100 Water Pump #91008



Natural Mongolian Basalt Column 36"

#98969

Approx. Packaged Weight: 375 lb
Dimensions: 10" diameter x 36"H

Recommended Pump:

Ultra 2000 Water Pump #91010



Natural Mongolian Basalt Columns Set of 3

#58062

Packaged Weight: 850 lb

Includes:

- (1)—10" diameter x 24"H
- (1)—10" diameter x 30"H
- (1)—10" diameter x 36"H



Mongolian Basalt Columns Set of 3 Landscape Fountain Kit

#58089

Approx. Packaged Weight: 963 lb

Kit Includes:

- (1) Natural Mongolian Basalt Columns Set of 3 (24", 30", 36")
- AquaBasin® 45
- Pond and Waterfall Foam Sealant
- Pre-cut Kink Free Pipe 3/4" x 6'
- Ultra 800 Water Pump



Mongolian Basalt Column 30" Landscape Fountain Kit

#58065

Approx. Packaged Weight: 442 lb

Kit Includes:

- (1) Natural Mongolian Basalt Column 30"
- AquaBasin® 45
- Pond and Waterfall Foam Sealant
- Pre-cut Kink-Free Pipe 3/4" x 12.5'
- Ultra 2000 Water Pump



Double-Textured Basalt Columns Set of 3

#98548

Packaged Weight: 276 lb

Includes:

- (1)—9" diameter x 20"H
- (1)—7" diameter x 13"H
- (1)—8" diameter x 8"H

Recommended:

AquaBasin® 30 #78223
Ultra 1100 Water Pump #91008
Kink-Free Pipe 3/4" x 6' #98404



Keyed Basalt Columns Set of 3

#98552

Packaged Weight: 246 lb

Includes:

- (1)—11" diameter x 18"H
- (1)—11" diameter x 12"H
- (1)—10" diameter x 6"H

Recommended:

AquaBasin® 30 #78223
Ultra 400 Water Pump #91005
Kink-Free Pipe 3/4" x 6' #98404



Semi-Polished Stone Basalt Columns Set of 3

#98264

Packaged Weight: 289 lb

Includes:

- (1)—7.5" diameter x 12"H
- (1)—7.5" diameter x 20"H
- (1)—10" diameter x 27"H

Recommended:

AquaBasin® 45 #78224
Ultra 400 Water Pump #91005
Kink-Free Pipe 3/4" x 6' #98404

Stacked Slate Spheres

NEW



Small Stacked Slate Sphere
#78287

Packaged Weight: 23 lb
Dimensions: 24" diameter x 22"H
Recommended Pump:
Ultra 800 Water Pump #91007

NEW



Medium Stacked Slate Sphere
#78288

Packaged Weight: 62 lb
Dimensions: 32" diameter x 30"H
Recommended Pump:
Ultra 1500 Water Pump #91009

NEW



Large Stacked Slate Sphere
#78289

Packaged Weight: 82.75 lb
Dimensions: 40" diameter x 37.5"H
Recommended Pump:
Ultra 2000 Water Pump #91010

NEW



Medium Stacked Slate Sphere
Landscape Fountain Kit
#78290

Packaged Weight: 171 lb
Kit Includes:

- Medium Stacked Slate Sphere
- AquaBasin® 45
- Ultra 1500 Water Pump
- Clear Vinyl Tubing

Fire Fountain Add-On Kit for the Stacked Slate Sphere



Fire Fountain Add-On Kit
for Stacked Slate Fountains
#78221

Packaged Weight: 4.5 lb
Packaged Dimensions: 10.5"L x 10.5"W x 7.5"H

Curved Stacked Slate Wall Bases

NEW



Small Curved Stacked Slate Wall Base

#78283

Packaged Weight: 23 lb
Dimensions: 36"L x 12"W x 13"H
Recommended Pump:
Ultra 2000 Water Pump #91010

NEW



Large Curved Stacked Slate Wall Base

#78282

Packaged Weight: 35 lb
Dimensions: 36"L x 12"W x 26"H
Recommended Pump:
Ultra 2000 Water Pump #91010

Curved Stacked Slate Wall Toppers

NEW



Front-Spill
Curved Stacked Slate Topper

#78284

Packaged Weight: 17 lb
Dimensions: 36"L x 12"W x 6"H

NEW



Rear-Spill
Curved Stacked Slate Topper

#78285

Packaged Weight: 17 lb
Dimensions: 36"L x 12"W x 6"H

NEW



Quad-Spill
Curved Stacked Slate Topper

#78286

Packaged Weight: 17 lb
Dimensions: 36"L x 12"W x 6"H

Stacked Slate Spillway Wall 32" Landscape Fountain Kit



Stacked Slate Spillway Wall 32"
Landscape Fountain Kit

#78269

Packaged Weight: 157 lb

Kit Includes:

- Large Curved Stacked Slate Wall Base
- Front-Spill Curved Stacked Slate Topper
- AquaBasin® 45
- Ultra 2,000 Water Pump
- Clear Vinyl Tubing

Straight Stacked Slate Wall Bases

NEW



Small Straight Stacked Slate Wall Base

#78279

Packaged Weight: 22 lb
Dimensions: 36"L x 12"W x 13"H
Recommended Pump:
Ultra 2000 Water Pump #91010

NEW



Large Straight Stacked Slate Wall Base

#78278

Packaged Weight: 41 lb
Dimensions: 36"L x 12"W x 26"H
Recommended Pump:
Ultra 2000 Water Pump #91010

Straight Stacked Slate Wall Toppers

NEW



Quad-Spill
Straight Stacked Slate Topper

#78280

Packaged Weight: 17 lb
Dimensions: 36"L x 12"W x 6"H

NEW



Front-Spill
Straight Stacked Slate Topper

#78281

Packaged Weight: 17 lb
Dimensions: 36"L x 12"W x 6"H

1. Choose a base.
2. Choose a topper.
3. Mix and match toppers and bases, linking them together to create beautiful, customized designs!



Create an S-Curve

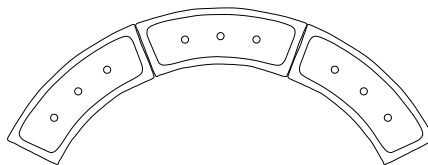

Create a Crescent

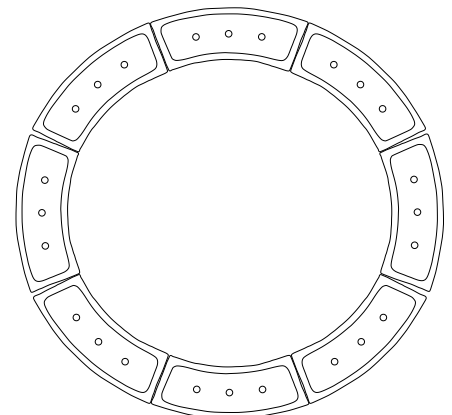

Create a Circle

Stacked Slate Urns



Small Stacked Slate Urn

#98939

Packaged Weight: 24.2 lb
Dimensions: 21.25" diameter x 33.5"H

Recommended Pump:
Ultra 550 Water Pump #91006



Medium Stacked Slate Urn

#78207

Packaged Weight: 53 lb
Dimensions: 27" diameter x 45"H

Recommended Pump:
Ultra 1100 Water Pump #91008



Large Stacked Slate Urn

#98940

Packaged Weight: 116 lb
Dimensions: 35.5" diameter x 55"H

Recommended Pump:
Ultra 2000 Water Pump #91010



Small Stacked Slate Urn
Fountain Kit

#58064

Packaged Weight: 39.2 lb
Kit Includes:
• Small Stacked Slate Urn
• DecoBasin
• Ultra 550 Water Pump



Medium Stacked Slate Urn
Landscape Fountain Kit

#58090

Packaged Weight: 163 lb
Kit Includes:
• Medium Stacked Slate Urn
• AquaBasin® 45
• Ultra 1,100 Water Pump
• Pre-Cut Kink-Free 3/4" x 6'



Fire Fountain Add-On Kit
for Stacked Slate Fountains

#78221

Packaged Weight: 4.5 lb
Packaged Dimensions: 10.5"L x 10.5"W x 7.5"H

Scalloped Urns



Small Scalloped Urn

#78238

Packaged Weight: 29 lb
Dimensions: 20" diameter x 32"H

Recommended Pump:
Ultra 550 Water Pump #91006



Medium Scalloped Urn

#78239

Packaged Weight: 59 lb
Dimensions: 27" diameter x 45"H

Recommended Pump:
Ultra 1100 Water Pump #91008



Large Scalloped Urn

#78240

Packaged Weight: 93 lb
Dimensions: 38" diameter x 56"H

Recommended Pump:
Ultra 2000 Water Pump #91010

Scalloped Urns (Continued)



Medium Scalloped Urn
Landscape Fountain Kit

#78270

Packaged Weight: 164 lb

Kit Includes:

- Medium Scalloped Urn
- AquaBasin® 45
- Ultra 1,100 Water Pump
- Clear Vinyl Tubing



Fire Fountain Add-On Kit
for Scalloped Urns

#78260

Packaged Weight: 4.5 lb

Packaged Dimensions: 10.5"L x 10.5"W x 7.5"H

Rippled Urns



Small Rippled Urn

#78241

Packaged Weight: 29 lb

Dimensions: 20" diameter x 32"H

Recommended Pump:

Ultra 550 Water Pump #91006



Medium Rippled Urn

#78242

Packaged Weight: 59 lb

Dimensions: 27" diameter x 45"H

Recommended Pump:

Ultra 1100 Water Pump #91008



Large Rippled Urn

#78243

Packaged Weight: 93 lb

Dimensions: 38" diameter x 56"H

Recommended Pump:

Ultra 2000 Water Pump #91010



Medium Rippled Urn
Landscape Fountain Kit

#78271

Packaged Weight: 164 lb

Kit Includes:

- Medium Rippled Urn
- AquaBasin® 45
- Ultra 1,100 Water Pump
- Clear Vinyl Tubing



Fire Fountain Add-On Kit
for Rippled Urns

#78267

Packaged Weight: 4.5 lb

Packaged Dimensions: 10.5"L x 10.5"W x 7.5"H

AquaBasin® 30 and 45

The AquaBasin® 30 and 45 are engineered to provide a trouble-free, easy-to-install fountain basin for a wide variety of decorative water feature installations, including natural stone, brass, and resin fountains. Their innovative design provides features and benefits that eliminate guesswork, improve water circulation, increase accessibility, and ensure a lifetime of enjoyment.

- Professional-grade, high-density polyethylene is built to last and backed by a lifetime warranty
- Structural deck cylinders reinforce basin strength and provide endless plumbing and lighting configurations
- Large, flat deck design makes it easy to set and position your choice of fountain
- Large corner pump access panel simplifies pump access, fits larger pumps, and sits elevated above the deck, preventing gravel from falling into the basin when removing the lid
- Square shape maximizes water storage capacity
- Protects pump and reduces maintenance



AquaBasin® 30
#78223

Packaged Weight: 22 lb
Dimensions: 30"L x 30"W x 10"H



AquaBasin® 45
#78224

Packaged Weight: 60 lb
Dimensions: 44.5"L x 44.5"W x 16"H



Features and Benefits of the AquaBasin® 45 and 30

- ① Large corner pump access panel fits larger pumps and sits elevated to prevent gravel from falling into the basin
- ② Pump and valve controls are easy to access for maintenance and adjusting water flow
- ③ Large, flat deck design makes it easy to set and position fountains
- ④ Professional-grade, high-density polyethylene construction
- ⑤ Drainage slots throughout the deck maximize water circulation
- ⑥ Structural deck cylinders provide endless plumbing and lighting port configurations, while reinforcing basin strength
- ⑦ Internal plumbing support allows plumbing to sit below the deck as it travels to the fountain(s), making installation simple and keeping plumbing out of sight

Basin Spec Chart

Item #	Model	Water Storage Capacity	Max Flow Rate	Dimensions	Warranty	Weight Capacity
78224	AquaBasin® 45	98 gal	4,000 GPH	44.5"L x 44.5"W x 16"H	Lifetime	1,500 lb
78223	AquaBasin® 30	27 gal	2,000 GPH	30"L x 30"W x 12"H	Lifetime	500 lb
76004	AquaBasin® Medium	40 gal	2,000 GPH	24"L x 24"W x 16"H	Lifetime	1,200 lb
98924	AquaBasin® Mini	8 gal	350 GPH	Top: 27"L x 20.5"W Base: 21"L x 14.5"W x 8"H	1-Year	50 lb
60000	DecoBasin	15 gal	1,500 GPH	22" diameter x 14.25"H	1-Year	100 lb
76000	Patio Basin	18 gal	550 GPH	31.5"L x 31.5"W x 8"H	1-Year	100 lb

Basins



AquaBasin® Medium
#76004

Packaged Weight: 20 lb

- Ideal reservoir for Aquascape paver fountains and WaterWall Spillway



AquaBasin® Mini
#98924

Packaged Weight: 6.5 lb

- Quick and easy to install



DecoBasin
#60000

Packaged Weight: 9 lb

- 5" diameter pump access hole
- 54" splash skirt prevents leakage or over-splash



Gray Patio Basin
#76000

Packaged Weight: 122 lb

- Allows for above-ground installation of decorative fountains

Decorative Accessories

NEW



Faux Oak Stump Cover
#78259

Packaged Weight: 19 lb
Dimensions: 15" diameter x 18.5"H

- Great for hiding outdoor electrical outlets
- Can also be used as a decorative garden accent or seat

NEW



Faux Driftwood 30"
#78276

Packaged Weight: 5.5 lb
Packaged Dimensions: 32.5"L x 10"W x 7.25"H

- Ideal for concealing hard-to-hide water feature components
- Great for use as a decorative accent

NEW



Faux Driftwood 35"
#78277

Packaged Weight: 6.5 lb
Packaged Dimensions: 36.25"L x 10.75"W x 8"H

- Ideal for concealing hard-to-hide water feature components
- Great for use as a decorative accent

Stainless Steel WaterWall Spillway

Incorporate beautiful, low-maintenance formal waterfalls into any design using the Aquascape Stainless Steel WaterWall Spillway.



Stainless Steel WaterWall Spillway

#58066

Packaged Weight: 9 lb

Kit Includes:

- Stainless steel construction for strength and corrosion resistance
- Clog-free, open-top design reduces maintenance
- 16" wide spillway and 1" plumbing port handles pumps up to 2,000 GPH



Stainless Steel WaterWall Spillway Kit

#58080

Packaged Weight: 40 lb

Kit Includes:

- Stainless Steel Waterfall Spillway (16")
- AquaBasin® Medium with splash pad
- Ultra Pump with plumbing components
- Garden and Pond 1-Watt LED Waterfall and Up Light
- Garden and Pond 6-Watt 12V Quick-Connect Transformer
- Compact Water Fill Valve



LINER, UNDERLAYMENT, AND GEOTEXTILE

Liner, underlayment, and geotextile are the pond's foundation. Educate yourself on the selection of liners that are available. Don't consider using a liner if it doesn't come with a long-term warranty. It is important to always determine whether the liner you choose is safe for fish that may inhabit the pond.

Underlayment is installed before the liner in order to prevent punctures that may occur from rough or rocky ground. The underlayment serves a couple of purposes. It not only provides protection for the liner against rocky soils and roots, but it allows the ground to breathe from underneath. The earth releases gases and the fabric allows the gases to escape from underneath the liner rather than becoming trapped, causing gas bubbles to push the liner up into the pond.



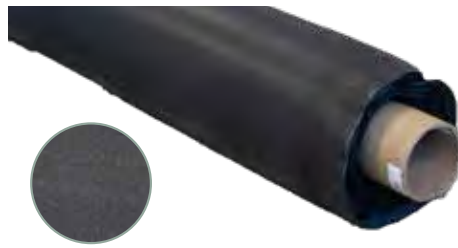

45 mil EPDM Liner Rolls

Aquascape 45 mil fish-safe EPDM pond liner leads the industry in quality and reliability. Backed by an industry leading 20-year guarantee, Aquascape pond liner is the choice of discerning pond professionals.

- Superior elongation and lay-flat characteristics
- Exceptional resistance to solar UV, ozone, and oxidation
- Ease of installation with no special tools required

<p>5' x 100' 45 mil EPDM Liner Roll #42002 Packaged Weight: 162 lb</p>	<p>10' x 50' 45 mil EPDM Liner Roll #29188 Packaged Weight: 162 lb</p>	<p>10' x 100' 45 mil EPDM Liner Roll #29189 Packaged Weight: 324 lb</p>
<p>15' x 50' 45 mil EPDM Liner Roll #29192 Packaged Weight: 243 lb</p>	<p>15' x 100' 45 mil EPDM Liner Roll #29193 Packaged Weight: 486 lb</p>	<p>20' x 50' 45 mil EPDM Liner Roll #29196 Packaged Weight: 324 lb</p>
<p>20' x 100' 45 mil EPDM Liner Roll #29197 Packaged Weight: 648 lb</p>	<p>25' x 50' 45 mil EPDM Liner Roll #29200 Packaged Weight: 402 lb</p>	<p>25' x 100' 45 mil EPDM Liner Roll #29201 Packaged Weight: 810 lb</p>
<p>30' x 50' 45 mil EPDM Liner Roll #29202 Packaged Weight: 486 lb</p>	<p>30' x 100' 45 mil EPDM Liner Roll #29203 Packaged Weight: 972 lb</p>	<p>40' x 50' 45 mil EPDM Liner Roll #29206 Packaged Weight: 678 lb</p>
<p>40' x 100' 45 mil EPDM Liner Roll #29207 Packaged Weight: 1295 lb</p>	<p>50' x 50' 45 mil EPDM Liner Roll #29210 Packaged Weight: 810 lb</p>	<p>50' x 100' 45 mil EPDM Liner Roll #29211 Packaged Weight: 1,619 lb</p>

* Larger roll lengths of 150' and 200' available. Call for availability!

45 mil EPDM Liner Mini Rolls

<p>20' x 25' 45 mil EPDM Liner Mini Roll #42018 Packaged Weight: 162 lb</p>	<p>20' x 30' 45 mil EPDM Liner Mini Roll #42019 Packaged Weight: 195 lb</p>
<p>25' x 30' 45 mil EPDM Liner Mini Roll #42020 Packaged Weight: 243 lb</p>	<p>30' x 30' 45 mil EPDM Liner Mini Roll #42021 Packaged Weight: 292 lb</p>



45 mil EPDM Boxed Liner

Aquascape 45 mil fish-safe EPDM pond liner boxed for convenience.

<p>8' x 10' 45 mil EPDM Boxed Liner #85009 Packaged Weight: 23 lb</p>	<p>10' x 10' 45 mil EPDM Boxed Liner #29607 Packaged Weight: 29 lb</p>	<p>10' x 12' 45 mil EPDM Boxed Liner #85000 Packaged Weight: 35 lb</p>
<p>10' x 20' 45 mil EPDM Boxed Liner #29612 Packaged Weight: 58 lb</p>	<p>10' x 30' 45 mil EPDM Boxed Liner #29616 Packaged Weight: 87 lb</p>	<p>12' x 15' 45 mil EPDM Boxed Liner #85001 Packaged Weight: 52 lb</p>
<p>15' x 15' 45 mil EPDM Boxed Liner #85002 Packaged Weight: 65 lb</p>	<p>15' x 20' 45 mil EPDM Boxed Liner #85003 Packaged Weight: 87 lb</p>	<p>20' x 25' 45 mil EPDM Boxed Liner #85004 Packaged Weight: 145 lb</p>

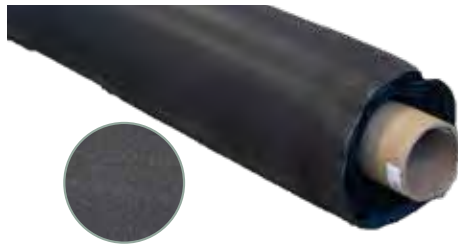

36 mil Reinforced Polypropylene Liner

Aquascape 36 mil Reinforced Polypropylene Liner is the optimal choice for large projects.

Cut to Size

#30336 • SPECIAL ORDER ONLY*

Packaged Weight: 0.185 lb/sq. ft.

*Minimum size 50 ft. x 100 ft.



Boxed Non-Woven Geotextile Underlayment

10' x 15'

Boxed Non-Woven Geotextile Underlayment

#85010

Packaged Weight: 5.7 lb



Non-Woven Geotextile Underlayment Roll

<p style="text-align: center;">5' x 300' Non-Woven Geotextile Underlayment Roll #30300</p> <p>Packaged Weight: 59 lb</p>	<p style="text-align: center;">15' x 300' Non-Woven Geotextile Underlayment Roll #29169</p> <p>Packaged Weight: 200 lb</p>
<p style="text-align: center;">7.5' x 600' Non-Woven Geotextile Underlayment Roll #29170</p> <p>Packaged Weight: 175 lb</p>	<p style="text-align: center;">Cut to Size Non-Woven Geotextile Underlayment Roll #29227</p> <p>Packaged Weight: 0.04 lb/sq. ft. over 900 sq.ft.</p>

Concrete Cloth, Rock Pad, and Woven Microgrid Geotextile



Concrete Cloth
Roll—3.63' x 30'
#85026

Packaged Weight: 156 lb

- Flexible cement impregnated fabric that hardens after hydration
- Acts as a protective barrier between liner and large rocks
- Protects liner from digging animals, vandalism, and more

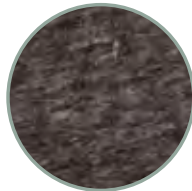

Rock Pad
3' x 3'
#25000

Packaged Weight: 1.1 lb

The rock pad is an extra thick 3' x 3' non-woven polypropylene fabric that can be laid down on the liner before placing those large rocks.

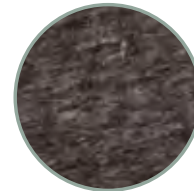

Rock Pad
Roll—15' x 150'
#25001

Packaged Weight: 260 lb

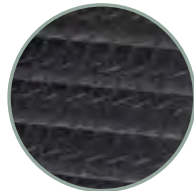

Woven Microgrid Geotextile
8' x 225'
#42016

Packaged Weight: 65 lb

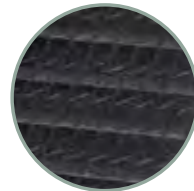

Woven Microgrid Geotextile
4' x 4'
#42015

Packaged Weight: 0.5 lb



PIPE AND PLUMBING

Flexible PVC Pipe makes installations quick and easy. The main advantage of this high-quality pipe is that it has the durability to be glued into standard schedule 40 PVC fittings.

- Simplifies plumbing layouts and installations
- Sun, ozone, and mildew resistant—NOTE: we do not recommend placing flexible PVC pipe in continuous sunlight
- Made in the USA

Kink-Free Pipe is an excellent choice for quick and easy installations without the use of PVC cement. This high quality Kink-Free Pipe is extremely flexible and resistant to crimping or collapsing around tight curves. Kink-Free Pipe works best when used with traditional stainless steel hose clamps and barbed fittings.

- Simplifies plumbing layouts and installations
- Internal spiral prevents crushing and smooth inner wall reduces friction and maximizes flow
- Made in the USA

Pre-cut Kink-Free Pipe is ideal for recirculating water in decorative fountains and other water features without the use of PVC cement. The pieces are cut and packaged in convenient six-foot sections, ideal for installations requiring smaller lengths of pipe.

- Internal spiral prevents crushing and smooth inner wall reduces friction and maximizes flow
- Works best when used with traditional barbed fittings and stainless steel hose clamps
- Made in the USA

Black Vinyl Tubing is ideal for recirculating water in fountains and other water features without the use of PVC glue. Our non-toxic, vinyl tubing is fish-safe, allowing for use in water features containing fish and plants.

- Durable construction
- Prevents kinking
- Flexibility makes installation quick and easy

Plumbing Materials provided by Aquascape include a complete selection of check valves, automatic water fill valves, and a variety of accessories, making it easy to complete any water feature with high quality plumbing products.

- Simplifies maintenance and installation
- Durable, professional quality products
- Easy to adapt to a variety of pipe types and sizes



Flexible PVC Pipe

<p>1" x 50' Flexible PVC Pipe #48015 Packaged Weight: 14.5 lb</p>	<p>1½" x 25' Flexible PVC Pipe #29021 Packaged Weight: 12 lb</p>	<p>1½" x 50' Flexible PVC Pipe #29022 Packaged Weight: 24 lb</p>
<p>2" x 25' Flexible PVC Pipe #29023 Packaged Weight: 16 lb</p>	<p>2" x 50' Flexible PVC Pipe #29024 Packaged Weight: 32 lb</p>	<p>3" x 50' Flexible PVC Pipe #29025 Packaged Weight: 65 lb</p>
	<p>3" x 100' Flexible PVC Pipe #29026 Packaged Weight: 130 lb</p>	



Kink-Free Pipe

<p>¾" x 25' Kink-Free Pipe #94002 Packaged Weight: 3.5 lb</p>	<p>1" x 25' Kink-Free Pipe #94001 Packaged Weight: 4 lb</p>	<p>1¼" x 25' Kink-Free Pipe #94000 Packaged Weight: 6 lb</p>
<p>1½" x 25' Kink-Free Pipe #94006 Packaged Weight: 8.4 lb</p>	<p>½" x 100' Kink-Free Pipe #98288 Packaged Weight: 8.4 lb</p>	<p>¾" x 100' Kink-Free Pipe #94003 Packaged Weight: 14 lb</p>
<p>1" x 100' Kink-Free Pipe #94004 Packaged Weight: 17.2 lb</p>	<p>1¼" x 100' Kink-Free Pipe #94005 Packaged Weight: 24.5 lb</p>	<p>1½" x 100' Kink-Free Pipe #94007 Packaged Weight: 34.5 lb</p>



Pre-Cut Kink-Free Pipe

<p>½" x 6' Pre-cut Kink-Free Pipe #88003 Packaged Weight: 0.85 lb</p>	<p>¾" x 6' Pre-cut Kink-Free Pipe #98404 Packaged Weight: 1 lb</p>
---	--



Black Vinyl Pipe

<p>$\frac{3}{8}$" x 100' Black Vinyl Tubing #94008 Packaged Weight: 5 lb</p>	<p>$\frac{3}{4}$" x 50' Black Vinyl Tubing #94010 Packaged Weight: 10.9 lb</p>	<p>$\frac{1}{2}$" x 100' Black Vinyl Tubing #94009 Packaged Weight: 6 lb</p>
	<p>1" x 50' Black Vinyl Tubing #94011 Packaged Weight: 13.6 lb</p>	

Check Valves and Flow Control Valves



Dual Union Check Valve 2.0
#48026

Packaged Weight: 10.9 lb

The Dual Union Check Valve 2.0 provides a professional pump and plumbing connection inside skimmer filter systems, as well as Pondless® Water Vaults.

- Connects the pump to water feature plumbing
- Innovative reversible fittings allow for universal application
- Prevents water backflow when the pump is not operating
- Dual-union, tool-free design makes maintenance quick and easy
- Height extendable for larger filters and pumps



Features of the Dual Union Check Valve 2.0

- ① Angled, swing-style valve effectively prevents back flow
- ② Heavy-duty flapper ensures longevity
- ③ Dual-union connections simplify pump and filter maintenance



Reversible Fittings Eliminate Guesswork



FITTINGS INCLUDED

2 x Reversible 2" MPT x 2" Slip,
1 x Reversible 1.5" FPT x 2" Slip



Dual Union 3" CVA Check Valve
#29098

Packaged Weight: 0.7 lb

The Dual Union 3" CVA Check Valve is ideal for larger installations that use large pumps and filters. Heavy-duty, dual-union design ensures years of trouble-free use.



2-Way Flow Control Valve
#88005

Packaged Weight: 1 lb

Water Fill Valves

Aquascape Water Fill Valves automatically add water to features when needed.

- Reduces time-consuming maintenance versus manually filling with a hose
- Helps protect pump from running dry
- Eliminates large water chemistry swings (including chlorine/chloramine levels) that occur during manual top-offs



Compact Water Fill Valve
#88006

Packaged Weight: 0.3 lb

- Up to 1.5 gallons per minute flow rate at a working pressure of 0-100 PSI
- Small size allows it to fit into any skimmer filter, Pondless® Waterfall Vault, or decorative water feature application
- Includes fittings to connect to a standard garden hose, 1/4" poly-pipe, 1/2" poly-pipe, 1/2" pvc pipe (pipe sold separately)



Water Fill Valve 200
#29272

Packaged Weight: 0.7 lb

- Up to 3 gallons per minute flow rate at a working pressure of 0-100 PSI
- Reliable mechanical arm-style fill valve
- Brass hardware with poly float
- Includes fittings to connect to 1/2" poly-pipe or 1/2" pvc pipe (pipe sold separately)



Hudson Water Fill Valve
#29469

Packaged Weight: 1.2 lb

- Up to 1.5 gallons per minute flow rate at working pressure of 8-65 PSI
- Works great in Signature Series Pond Skimmers and Pondless® Waterfall Vault
- Mounting plate allows 4-inch setting adjustments
- Includes quick-connect fitting for 1/4" poly pipe
- Can also be used with 1/2" PVC by using the Fill Valve Irrigation Conversion Kit (Item #01008)

Water Fill Valve Accessories



Fill Valve Spigot 1/4" Quick-Connect
#07000

Packaged Weight: 0.2 lb

Connects 1/4" poly pipe to garden spigot.



Garden Hose Adapter Assembly
#29517

Packaged Weight: 0.2 lb

Connects 1/2" poly pipe to garden spigot.



Fill Valve Irrigation Conversion Kit
#01008

Packaged Weight: 0.05 lb

Converts the 1/4" Hudson Water Fill Valve up to 1/2" poly pipe or PVC.



WFV Poly Pipe Roll
1/4" x 100'
#29350

Packaged Weight: 1.3 lb



WFV Poly Pipe Roll
1/2" x 100'
#29470

Packaged Weight: 6.1 lb



INSTALLATION TOOLS

Whether you are a do-it-yourselfer or professional water feature contractor, Aquascape has all the pieces and parts you need for successful installation or repair. Installation tools, spare parts, and accessories are available individually or as part of a kit. Installation tools located within this section of the catalog include the following.

- Foam
- Foam Guns
- Patches
- Silicone
- Glue

Installation Tools



Economy Foam Gun Applicator
#54003

Packaged Weight: 1.1 lb

We've added an economy model of our popular professional-grade foam gun. This lower-priced foam gun provides an attractive price point so that all contractors, no matter how many features they build, can afford to add a foam gun to their pond-building tool kit. To be used with Professional Black Waterfall Foam.



Professional Foam Gun Applicator
#29268

Packaged Weight: 0.8 lb

Aquascape Professional Foam Gun Applicator is designed to create an air and moisture-tight seal between the gun and the can, allowing for maximum foam yield and minimal waste. To be used with Professional Black Waterfall Foam.



Professional Foam Gun Kit
#22013

Packaged Weight: 13.5 lb.

Kit includes:

- Case
- Professional Black Waterfall Foam
- Professional Foam Gun Applicator
- Professional Foam Gun Cleaner



Professional Black Waterfall Foam
#30096

Packaged Weight: 2.2 lb

24 oz. can of expandable Professional Black Waterfall Foam. Equivalent to five Pond and Waterfall Foam Sealant. To be used with foam guns (sold separately).



Professional Foam Gun Cleaner
#22011

Packaged Weight: 1.1 lb

A handy cleaner to flush the foam gun clean if it is not working properly. It will also remove uncured foam.



Installation Kit
#22008

Packaged Weight: 2.2 lb

Kit includes:

- Liner Patch
- Christy's Red Hot Blue Glue
- Black Silicone Sealant
- Pond and Waterfall Foam Sealant



Pond and Waterfall Foam Sealant
#21053

Packaged Weight: 1.2 lb

No gun applicator needed! Easy to use for the beginner or do-it-yourselfer. Convenient and economical for a small project or the quick touch-up on a larger project. Also sold as part of our Installation Kit (#22008).



Black Silicone Sealant
4.7 oz
#22010

Packaged Weight: 0.4 lb

- Used for sealing joints where liner attaches to biofilter lip and the skimmer faceplate
- Fish-safe



Black Silicone Sealant
10.1 oz
#29186

Packaged Weight: 0.6 lb

- Used for sealing joints where liner attaches to biofilter lip and the skimmer faceplate
- Fish Safe

Installation Tools (Continued)

NEW



Clear Silicone Sealant

10.1 oz
#82000

Packaged Weight: 0.6 lb

- Used for sealing joints where liner attaches to biofilter lip and the skimmer faceplate
- Fish Safe



Cleanout Pump

#45033

Packaged Weight: 25 lb

- Great for pond cleanouts and installation wash-downs
- 4,200 GPH for fast pump-outs
- Pumps water down to 1/4" off the bottom



Cleanout Pump Discharge Hose 50'

#48019

Packaged Weight: 14.75 lb

- Heavy-duty cleanout discharge hose engineered for flexibility and optimal flow
- Swivel cuff fitting prevents kinking or tangling, allowing easy movement around the water feature



Firestone® QuickSeam Pond Liner Repair Kit

#42023

Packaged Weight: 0.5 lb

Kit includes:

- 6" x 6" QuickSeam patches
- Bottle of LVOC Primer (2 oz/57 ml)
- Scrubber pad
- Patch roller
- Pair of disposable gloves



Firestone® QuickScrubber Kit

#54009

Packaged Weight: 0.75 lb

Kit consists of 30 scrub pads and 4 holders designed for the application of Firestone® QuickPrime Plus—EPDM Liner Seaming Tape Primer.



Firestone® QuickPrime Plus—EPDM Liner Seaming Tape Primer

1 qt. / 0.95 L

#54008

Packaged Weight: 1 lb

QuickPrime Plus is designed to clean and prime EPDM liner prior to seaming.



EPDM Liner Patch 6"

#22018

Packaged Weight: 0.1 lb

This 6" self-adhesive patch quickly repairs holes, tears, and cuts in liner.



EPDM Liner One-Sided Cover Tape

6" x 25'

#22003

Packaged Weight: 5.8 lb



EPDM Liner One-Sided Cover Tape

6" x 100'

#22005

Packaged Weight: 20 lb



Christy's Red Hot Blue Glue

4 oz

#29969

Packaged Weight: 0.4 lb

The original all-weather, wet or dry PVC cement.



EPDM Liner Double-Sided Seam Tape

3" x 25'

#22017

Packaged Weight: 1.5 lb



EPDM Liner Double-Sided Seam Tape

3" x 100'

#22020

Packaged Weight: 7.8 lb



RAINWATER HARVESTING

Why Harvest Rainwater?

The Aquascape Rainwater Harvesting System (formerly known as RainXchange®) is a sustainable solution for water conservation and stormwater management.

Water Conservation

- According to the World Wildlife Fund, 1.1 billion people worldwide lack access to water and by 2025, two-thirds of the world's population may face water shortages.*
- Capturing and reusing rainwater reduces the community's demand on the municipal water supply, reduces the owner's water bills, and helps avoid strict water schedules.

Stormwater Management

- According to the EPA, stormwater run-off is one of the main reasons that our lakes, rivers, and estuaries are not clean enough for fishing or swimming.**
- Rainwater harvesting is a solution for managing stormwater run-off and decreasing flooding.
- Federal, state, and local regulations are requiring stormwater to be managed at the source. The Aquascape Rainwater Harvesting System provides a solution to help meet these governmental regulations.

*"Water Scarcity." WorldWildlife.org. World Wildlife Fund, n.d. Web. 10 Nov. 2016.

**National Research Council. "Urban Stormwater Management in the United States." The National Academies Press. Web. 15 Oct. 2008.

Aquascape Rainwater Harvesting System Components —Pondless® Waterfall—

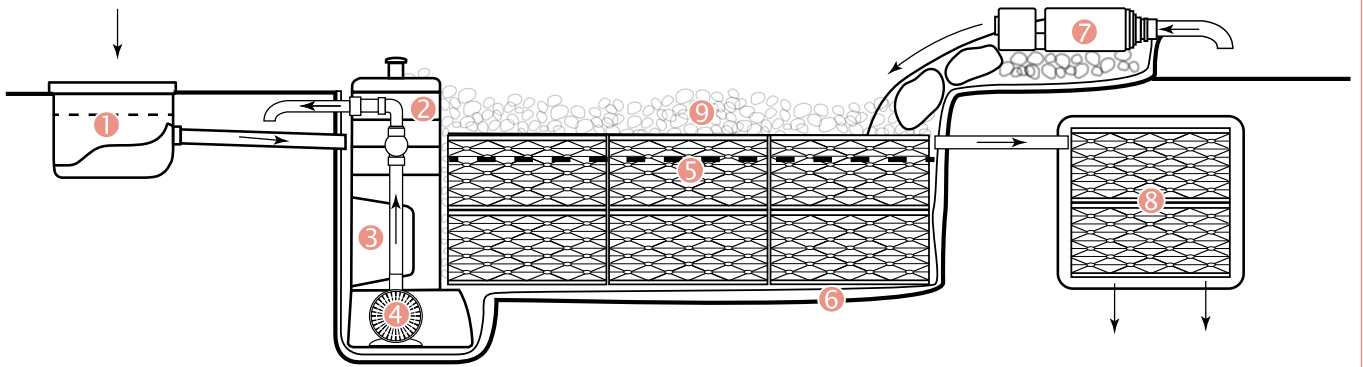

- | | | |
|--|-----------------------------------|----------------------|
| ① Downspout Filter | ④ Pump | ⑦ Waterfall Spillway |
| ② Pondless® Waterfall Vault Extensions | ⑤ AquaBlox® Water Storage Modules | ⑧ Overflow Drainage |
| ③ Pondless® Waterfall Vault | ⑥ Liner and Underlayment | ⑨ Rocks and Gravel |

Aquascape Rainwater Harvesting System Components —Fountain—

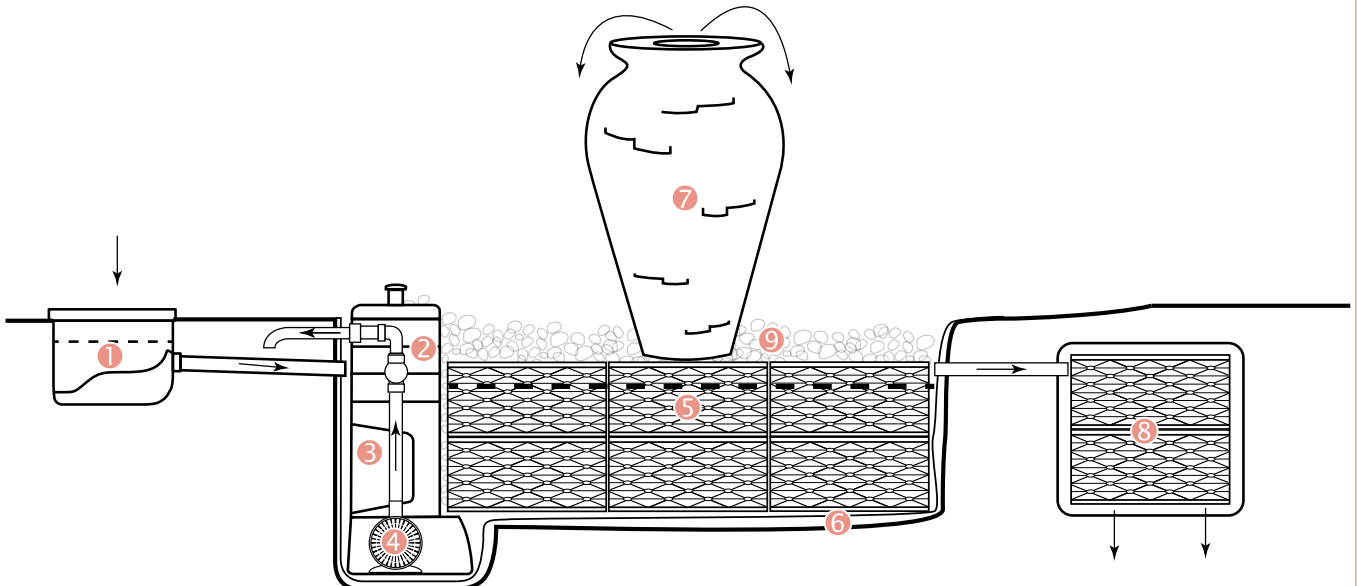

- | | | |
|--|-----------------------------------|-----------------------|
| ① Downspout Filter | ④ Pump | ⑦ Decorative Fountain |
| ② Pondless® Waterfall Vault Extensions | ⑤ AquaBlox® Water Storage Modules | ⑧ Overflow Drainage |
| ③ Pondless® Waterfall Vault | ⑥ Liner and Underlayment | ⑨ Rocks and Gravel |



Rainwater Harvesting System Water Storage Kits

Each Aquascape Rainwater Harvesting System Water Storage Kit Includes: Pondless® Waterfall Vault Extension(s), AquaBlox®, 45 mil EPDM Liner, and two pieces of non-woven geotextile underlayment (one to surround the AquaBlox® and one to surround the exterior of the EPDM liner).

<p style="text-align: center;">500 Gallon Water Storage Kit #30097</p> <ul style="list-style-type: none"> • Basin Size: 6' x 9' x 4' • (16) AquaBlox® Large Water Storage Modules • 45 mil EPDM Liner—15' x 20' • (2) Underlayment—300 sq. ft. • Pondless® Waterfall Vault Extension 	<p style="text-align: center;">1000 Gallon Water Storage Kit #30099</p> <ul style="list-style-type: none"> • Basin Size: 6' x 9' x 5' • (32) AquaBlox® Large Water Storage Modules • 45 mil EPDM Liner—20' x 25' • (2) Underlayment—500 sq. ft. • (4) Pondless® Waterfall Vault Extensions 	<p style="text-align: center;">1500 Gallon Water Storage Kit #30102</p> <ul style="list-style-type: none"> • Basin Size: 8' x 9' x 5' • (48) AquaBlox® Large Water Storage Modules • 45 mil EPDM Liner—25' x 25' • (2) Underlayment—625 sq. ft. • (4) Pondless® Waterfall Vault Extensions
<p style="text-align: center;">2000 Gallon Water Storage Kit #30105</p> <ul style="list-style-type: none"> • Basin Size: 9' x 11' x 5' • (64) AquaBlox® Large Water Storage Modules • 45 mil EPDM Liner—25' x 30' • (2) Underlayment—750 sq. ft. • (4) Pondless® Waterfall Vault Extensions 	<p style="text-align: center;">2500 Gallon Water Storage Kit #30108</p> <ul style="list-style-type: none"> • Basin Size: 11' x 12' x 5' • (80) AquaBlox® Large Water Storage Modules • 45 mil EPDM Liner—25' x 30' • (2) Underlayment—750 sq. ft. • (4) Pondless® Waterfall Vault Extensions 	<p style="text-align: center;">3000 Gallon Water Storage Kit #30112</p> <ul style="list-style-type: none"> • Basin Size: 9' x 11' x 6' • (96) AquaBlox® Large Water Storage Modules • 45 mil EPDM Liner—25' x 30' • (2) Underlayment—750 sq. ft. • (6) Pondless® Waterfall Vault Extensions

Rainwater Harvesting Water Feature Add-On Kits



Rainwater Harvesting Fountain Add-On Kit

#44000

Select from a number of decorative bubbling urns and stone fountains (seen on pages 90-108) that sit on top of the Aquascape Rainwater Harvesting System. The water spills over the top of the decorative piece and flows back down into the Aquascape Rainwater Harvesting Water Storage System where it is re-circulated.

Kit Includes:

- Pondless® Waterfall Vault
- Downspout Filter
- AquaSurge® 2000-4000 Adjustable Flow Pond Pump
- Kink-Free Pipe—3/4" x 25'
- Overflow Kit
- Decorative Fountain Component Bag



Rainwater Harvesting Pondless® Waterfall Add-On Kit

#44001

This water feature is made up of a waterfall or stream that flows and then disappears gracefully into the gravel.

Kit Includes:

- Pondless® Waterfall Vault
- Waterfall Spillway
- Downspout Filter
- AquaSurge® 2000-4000 Adjustable Flow Pond Pump
- LED Lighting Package
- Flexible PVC Pipe—2" x 25'
- 45 mil EPDM Liner—10' x 20'
- Overflow Kit
- Installation Kit

Index

Symbols

- 2-Outlet Pond Aeration Kit 49
 - 2-Watt LED Color-Changing Waterfall and Up Light 54
 - 2-Way Aeration Compressor Manifold 51
 - 2-Way Flow Control Valve 115
 - 3-Way Color-Changing Splitter 57
 - 4.5-Watt LED Color-Changing Spotlight 54
 - 4-Outlet Pond Aeration Kit 49
 - 6-Way Color-Changing Splitter 57
 - 8-Watt LED Color-Changing Spotlight 54
 - 10" Rubber Membrane Aeration Diffuser 51
 - 25' 5-Outlet Color-Changing Lighting Extension Cable 57
 - 25' Color-Changing Lighting Extension Cable 57
 - 36 mil Reinforced Polypropylene Liner 111
 - 45 mil EPDM Boxed Liner 111
 - 45 mil EPDM Liner Mini Rolls 110
 - 45 mil EPDM Liner Rolls 110
 - 70 GPH Water Pump 46
 - 90 GPH Water Pump 46
 - 180 GPH Water Pump 46
 - 300-Watt Pond De-Icer 80
 - 320 GPH Water Pump 46
- ## A
- Activated Pond Carbon 71
 - Adjustable Pouring Bamboo Fountain 94
 - Aeration 48
 - Algaecide 70
 - Alkalinity Booster 71
 - Alligator Spitter 95
 - Ammonia Neutralizer 71
 - Ammonia Neutralizer Contractor Grade 74
 - Amphora Vase Fountain and Kit 96
 - Amphora Vase Fountain Kit 96
 - AquaBasin® 30 106
 - AquaBasin® 45 106
 - AquaBasin® Medium 107
 - AquaBasin® Mini 107
 - AquaBlox® Water Storage Module 26
 - AquaForce® Adjustable Flow Solids-Handling Pond Pump 39
 - AquaForce® Solids-Handling Pond Pumps 38
 - AquaJet® Pond Pump 41
 - Aquamarine Fire Glass 91
 - AquaRock Fountain Kits 94
 - AquascapePRO Pond Pumps 36
 - AquaSurge® Adjustable Flow Pond Pumps 32
 - AquaSurge® Pond Pumps 31
 - Aquatic Patio Pond Kit 92
 - Aquatic Plant Care 87
 - Aquatic Planters 88
 - Automatic Dosing System 62
 - Automatic Dosing System for Fountains 62
- ## B
- Automatic Dosing System for Ponds 62
 - Automatic Dosing System Water Treatments 63
 - Backyard Waterfall Landscape Fountain Kit 12, 98
 - Bacteria Bubble Tabs 68
 - Barbed Coupling 3/8" 51
 - Barley Straw Extract 69
 - Barley Straw Extract Contractor Grade 75
 - Beneficial Bacteria 67
 - Beneficial Bacteria Concentrate 67
 - Beneficial Bacteria Concentrate Contractor Grade 74
 - Beneficial Bacteria Contractor Grade 74
 - BioBalls Biological Filter Media 28
 - BioBalls Filter Media Net 28
 - BioFalls® Filters 16
 - Black Pond Dye 68
 - Black Silicone Sealant 118
 - Black Vinyl Pipe 115
 - Blue Heron Decoy 78
 - Blue Pond Tint 68
 - Boxed Non-Woven Geotextile Underlayment 111
 - Bulk Protective Pond Netting 81
- ## C
- Christy's Red Hot Blue Glue 119
 - Clean for Fountains 65
 - Clean for Ponds 64
 - Cleanout Pump 40, 119
 - Cleanout Pump Discharge Hose 50' 40, 119
 - Clear for Ponds 64
 - Clear Silicone Sealant 119
 - Coarse Filter Media Roll 1.25" Thick 29
 - Coarse Filter Media Roll 2" Thick 29
 - Cold Water Beneficial Bacteria 67
 - Cold Water Beneficial Bacteria Contractor Grade 74
 - Collapsible Pond and Fish Net 85
 - Collapsible Pond Skimmer Net 85
 - Color-Changing Lighting Control Hub 57
 - Compact Water Fill Valve 116
 - Concentrated Barley Straw Pellets 68
 - Concrete Cloth 112
 - Container Water Garden Filter 28
 - Contractor Grade Water Treatments 74, 75
 - Crane with Lowered Head Spitter 95
 - Crazy Legs Frog Spitter 95
 - CU/Copper Test Kit 23
 - Curved Stacked Slate Wall 102
- ## D
- DecoBasin 107
 - Decorative 90
 - Decorative River Pebbles 93
 - Deer Scarer Bamboo Fountain 94
 - Dense Filter Media Roll 1" Thick 29
 - Desert Granite Patio Pond 93
 - DIY Backyard Pond Kit 8
- ## E
- DIY Backyard Waterfall Kit 12
 - Double Frog with Cattail Spitter 95
 - Double-Textured Basalt Columns Set of 3 100
 - Dragonfly Spitter 95
 - Dual Union 3" CVA Check Valve 115
 - Dual Union Check Valve 2.0 115
- ## E
- EcoBlast™ Contact Granular Algaecide 70
 - Economy Foam Gun Applicator 118
 - EcoWave Pond Pumps 42, 43
 - EPDM Liner Double-Sided Seam Tape 119
 - EPDM Liner One-Sided Cover Tape 119
 - EPDM Liner Patch 6" 119
 - European Terra Cotta Patio Pond 93
 - Extension Cables 56
- ## F
- Faux Driftwood 30" 107
 - Faux Driftwood 35" 107
 - Faux Oak Stump Cover 107
 - Fill Valve Irrigation Conversion Kit 116
 - Fill Valve Spigot 1/4" Quick-Connect 116
 - Filtration 14
 - Fire Fountains 91
 - Fire Fountain Add-On Kit for Rippled Urns 91, 105
 - Fire Fountain Add-On Kit for Scalloped Urns 91, 105
 - Fire Fountain Add-On Kit for Stacked Slate Fountains 91, 101, 104
 - Fire Fountain Add-On Kits 91
 - Fire Fountains 91
 - Fire Glass 91
 - Firestone® QuickPrime Plus—EPDM Liner Seaming Tape Primer 119
 - Firestone® QuickScrubber Kit 119
 - Firestone® QuickSeam Pond Liner Repair Kit 119
 - Fish Care 82
 - Fish Food 84
 - Flexible PVC Pipe 114
 - Floating Alligator Decoy 78
 - Floating Plant Island 88
 - Fountain Foam Free 72
 - Fountain Maintenance 73
 - Fountain Scale Free 73
 - Fountain Shims 93
 - Frog on Reed Spitter 95
 - Fungus Treatment 86
- ## G
- Garden and Pond 1-Watt LED Spotlight 53
 - Garden and Pond 1-Watt LED Spotlight 6-Pack 59
 - Garden and Pond 1-Watt LED Waterfall and Up Light 53
 - Garden and Pond 1-Watt LED Waterfall and Up Light 6-Pack 59
 - Garden and Pond 3-Watt LED Spotlight 53
 - Garden and Pond 3-Watt LED Spotlight 6-Pack 59
 - Garden and Pond 3-Way Quick-Connect Splitter 56
 - Garden and Pond 6-Watt 12V Quick-Connect Transformer 58
 - Garden and Pond 6-Watt LED Spotlight 53
 - Garden and Pond 6-Watt LED Spotlight 6-Pack 59
 - Garden and Pond 6-Way Quick-Connect Splitter 56
 - Garden and Pond 20-Watt 12V Quick-Connect Transformer 58
 - Garden and Pond 25' 5-Outlet Quick-Connect Lighting Extension Cable 56
 - Garden and Pond 25' Quick-Connect Lighting Extension Cable 56
 - Garden and Pond 60-Watt 12V Quick-Connect Transformer 58
 - Garden and Pond 60-Watt Transformer with Photocell 58
 - Garden and Pond 150-Watt Transformer with Photocell 58
 - Garden and Pond LED Lights 53
 - Garden and Pond LED Spotlight Kit 53
 - Garden and Pond Photocell with Digital Timer 56
 - Garden Hose Adapter Assembly 116
 - Green Slate Patio Pond 93
- ## H
- Heavy Duty Pond Net with Extendable Handle 85
 - Heavy Duty Pond Skimmer Net with Extendable Handle 85
 - High Density Rigid Filter Mat 29
 - Hudson Water Fill Valve 116
- ## I
- Installation Kit 118
 - IonGen™ G2 Probe Holder 23
 - IonGen™ Probe for the G1.5 System 23
 - IonGen™ Probe for the G2 System 23
 - IonGen™ System G2 22
- ## K
- Keyed Basalt Columns Set of 3 100
 - KH/Alkalinity Test Kit 23
 - Kid's Pond Explorer Net 85
 - Kink-Free Pipe 114
 - Koi Krunchies 84
- ## L
- Lake Bacteria 76
 - Lake Bacteria Packs 76
 - Lake Blue Dye Packs 76
 - Lake Flocculant Clarifier 77
 - Lake Phosphate Binder Packs 77
 - Lake Sludge Remover Packs 76
 - Lake Treatment Booster Packs 77
 - Large Centipede® Module 27
 - Large Pond Kit 21' x 26' with 9-PL 7000 Solids-Handling Pond Pump 9
 - Large Pond Kit 21' x 26' 9
 - Large Pondless® Waterfall Kit 26' Stream 13

Index (Continued)

Large Snorkel® Vault and Cap 27
Lazy Frog on Lily Pad Spitter 95
Leaning Vase Fountain and Kit 96
Leaning Vase Fountain Kit 96
LED Color-Changing Fountain Light 55
LED Color-Changing Fountain Light with Transformer 55
LED Fountain Light 54
LED Fountain Light with Transformer 54
LED Lighting 6-Packs 59
Lighting 52
Liner, Underlayment, and Geotextile 109
Low Density Rigid Filter Mat 29

M

Maintain for Ponds 64
Maintenance Tabs 72
Man in Barrel Spitter 95
Medium Density Rigid Filter Mat 29
Medium Pond Kit 11' x 16' 9
Medium Pondless® Waterfall Kit 16' Stream 13
Medium Rippled Urn Landscape Fountain Kit 97, 105
Medium Scalloped Urn Landscape Fountain Kit 97, 105
Medium Stacked Slate Sphere Landscape Fountain Kit 97, 101
Medium Stacked Slate Urn Landscape Fountain Kit 97, 104
Mini Stacked Slate Urn Fountain 96
Mini Stacked Slate Urn Fountain Kit 96
Mongolian Basalt Column 30" Landscape Fountain Kit 97, 100
Mongolian Basalt Columns Set of 3 Landscape Fountain Kit 97, 100

N

Natural Mongolian Basalt Column 24" 100
Natural Mongolian Basalt Column 30" 100
Natural Mongolian Basalt Column 36" 100
Natural Mongolian Basalt Columns Set of 3 100
Naughty Dog Spitter 95
Nets 85
Non-Woven Geotextile Underlayment Roll 112

O

Once-A-Year Pond Plant Fertilizer 13-13-13 89

P

Pagoda Fountain Rocks Set of 3 99

Pagoda Fountain Rocks Set of 3 Landscape Fountain Kit 97, 99
Parasite & Ich Treatment 86
Path and Area 3-Watt LED Dome Top Landscape Light 55
Path and Area 3-Watt LED Dome Top Landscape Light 6-Pack 59
Path and Area 3-Watt LED Hat Top Landscape Light 55
Path and Area 3-Watt LED Hat Top Landscape Light 6-Pack 59
Path and Area LED Landscape Lights 55
Patio Basin 107
Patio Pond Maintenance Tabs 72
Patio Ponds 92, 93
Photocell 56
Pipe and Plumbing 113
PL Solids-Handling Pond Pumps 34
PN Solids-Handling Pond Pumps 34
Pond Aeration Kits 49
Pond Aerator Aeration Disc 49
Pond and Waterfall Foam Sealant 118
Pond & Debris Clarifier Contractor Grade 75
Pond Detoxifier Contractor Grade 74
Pond Detoxifier 71
Pond Filter Urn 25
Pond Foam Free 71
Pond Kits 6
Pondless® Waterfall Kits 10
Pondless® Waterfall Vault 17
Pondless® Waterfall Vault Extension 17
Pond Net with Extendable Handle 85
Pond Plant Fertilizer 89
Pond Plant Fertilizer 10-14-8 89
Pond Plant Potting Media 89
Pond Powerhead 47
Pond Salt 73, 86
Pond Shark 85
Pond Shark Pro 85
Pond Skimmer Filters 15
Pond Skimmer Net with Extendable Handle 85
Pond Sludge Remover Packs 72
Pond Starter Bacteria 68
Pond Starter Bacteria Contractor Grade 75
Pond Waterfall Filter 25
Pouring 3-Tier Bamboo Fountain 94
Praziquantel Treatment 86
Pre-Cut Kink-Free Pipe 114
Predator Control 78
Premium Cold Water Fish Food Pellets 83
Premium Color Enhancing Fish Food Pellets 84
Premium Fish Food Flakes 84
Premium Staple Fish Food Pellets 83
Prevent for Fountains 65
Pro Air 20 Aeration Compressor 51
Pro Air 20 Pond Aeration Kit 50
Pro Air 60 Aeration Compressor 50, 51
Pro Air 60 Pond Aeration Kit 50
Pro Air Pond Aeration Kits 50

Professional Black Waterfall Foam 118
Professional Fish Net with Extendable Handle 85
Professional Foam Gun Applicator 118
Professional Foam Gun Cleaner 118
Professional Foam Gun Kit 118
Professional Grade Pond Net 85
Professional Grade Pond Skimmer Net 85
Protect for Ponds 65
Protective Pond Netting 80
Pumps 30

Q

QuickFix Pond Gummy 70

R

Rainwater Harvesting Fountain Add-On Kit 123
Rainwater Harvesting Pondless® Waterfall Add-On Kit 123
Rainwater Harvesting System Water Storage Kits 122
Rapid Clear Fine Filter Pads 29, 69
Rapid Clear Flocculant 69
Rapid Clear Flocculant Contractor Grade 75
Reflective Black Fire Glass 91
Reflective Cobalt Blue Fire Glass 91
Rippled Urn 105
Rock and Fountain Cleaner 72
Rock Pad 112
Rock Pad Roll 112

S

SAB Stream & Pond Cleaner 69
SAB Stream & Pond Cleaner Contractor Grade 75
Scalloped Urn 104
Seasonal Care 79
Semi-Polished Stone Basalt Columns Set of 3 100
Signature Series 200 Pond Skimmer 15
Signature Series 400 Pond Skimmer 15
Signature Series 1000 BioFalls® Filter 16
Signature Series 1000 Pond Skimmer 15
Signature Series 2500 BioFalls® Filter 16
Signature Series 6000 BioFalls® Filter with 2" Bulkhead 16
Signature Series 6000 BioFalls® Filter with 3" Bulkhead 16
Sludge Cleaner Bubble Tabs 72
Sludge & Filter Cleaner 72
Sludge & Filter Cleaner Contractor Grade 74
Small Pond Kit 8' x 11' 8
Small Pondless® Waterfall Kit 6' Stream 12
Small Stacked Slate Urn Fountain Kit 104
Snorkel® Vault Extension 27

Spillway Basin 40" 99
Spillway Bowl 32" 99
Spillway Bowl and Basin Landscape Fountain Kit 97, 99
Spillway Bowl Stand 99
Splitters 56
Stacked Slate Spheres 101
Stacked Slate Spillway Wall 32" Landscape Fountain Kit 97, 102
Stacked Slate Topper 102
Stacked Slate Urn 104
Stacked Slate Walls 102, 103
Stainless Steel WaterWall Spillway 108
Stainless Steel WaterWall Spillway Kit 108
Standing Crane Spitter 95
Statuary Water Pumps 46
Stone Basalt Columns 100
Straight Stacked Slate Topper 103
Straight Stacked Slate Wall Base 103
Submersible Pond Filter 20
Submersible Pond Thermometer 80
Swirly Vase Fountain and Kit 96
Swirly Vase Fountain Kit 96

T

Textured Gray Slate Patio Pond 92
Toucan Spitter 95
Transformers 58

U

Ulcer & Bacterial Treatment 86
UltraKlear™ Pond Filters 18
UltraKlear™ Pond Filtration Kits 19
UltraKlear® UV Clarifier 24
Ultra Water Pump Fountain Head Kits 45
Ultra Water Pumps 44
U-Shaped Ground Stakes 81

W

Waterfall & Rock Cleaner Contractor Grade 75
Waterfall Spillway 21
Water Fill Valve 200 116
Water Fill Valves 116
Water Storage Kits 122
Water Treatments 61, 75
Weighted Aeration Tubing 51
WFFV Poly Pipe Roll 116
Woven Microgrid Geotextile 112





The Aquascape Foundation is a nonprofit 501(c)(3) organization established in 2008. The mission of the Foundation is to create sustainable solutions for the world-wide water crisis. The purpose of the Foundation is to promote awareness of water as our most precious resource through environmental, educational and philanthropic efforts. One of the ways we accomplish this mission is by utilizing a modified version of the Aquascape Rainwater Harvesting System as a solution to bring clean drinking water to places where people currently have no access. The Foundation also funds the installation of borehole water well systems in areas with unsanitary water sources.

The Aquascape Foundation is utilizing its core technology to end this needless suffering. With this technology we can capture, purify and store thousands of gallons of rainwater, making it accessible and potable. Our technology will not only bring health and wellness to a community, but with an accessible water source, children can focus on education and adults can focus on employment. It's a smart and sustainable solution to a complex problem. Water is Life!



**TO LEARN MORE AND MAKE A DONATION, PLEASE VISIT
AQUASCAPEFOUNDATION.ORG**



1200 Creditstone Rd., Unit 1 • Concord, Ontario L4K 5T2
Toll Free: (866) 766-3426
Customer Service Fax: (905) 454-7310
Email: customerservicecanada@aquascapeinc.com

2019 Aquascape, Inc.
All Worldwide Rights Reserved.



Visit Us on Our NEW Website!
aquascapeinc.com



E-Newsletter
bit.ly/pondsidemonthly



Join Us
facebook.com/aquascapeinc



Learn More
youtube.com/aquascape4



Be Inspired
pinterest.com/aquascapeinc



Connect with Us
twitter.com/aquascapeinc



Greg Wittstock, The Pond Guy Vlog
youtube.com/gregwittstockthepondguy